

Supplement

24.1



SANDVIK
COROMANT

Turning
Parting and grooving
Milling
Turning tool adaptors

GENERAL TURNING

CoroTurn® Prime
CoroTurn® TR
CoroTurn® 107
T-Max® P
T-Max®

PARTING AND GROOVING

CoroCut® 2
CoroCut® QD
CoroCut® XS

MILLING

CoroMill® MR80
CoroMill® 365
CoroMill® MS60
CoroMill® Plura ball nose

TURNING TOOL ADAPTORS

CoroTurn® SL damped adaptor
CoroTurn® SL quick change damped adaptor

ACCESSORIES

Tool status checker for CoroTurn® SL

For complete assortment, see www.sandvik.coromant.com

General turning

CoroTurn® Prime

Inserts 3

CoroTurn® TR

Inserts 4
Cutting unit 27

CoroTurn® 107

Inserts 5
Cutting unit 35
QS™ shank tools 41

T-Max® P

Inserts 13
Cutting unit 42
QS™ shank tools 47

T-Max®

Inserts 26

CoroTurn® Prime insert for turning

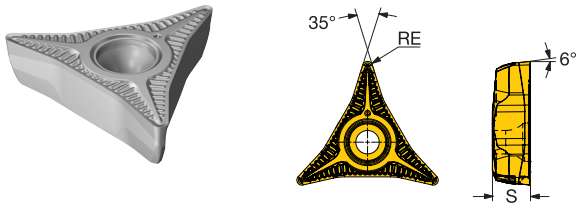

A-type insert

					M	S
Finishing	SSC	S	RE	ISO CODE	1210	1210
	CP-A	6.00	0.8	CP-A1108-L3	☆	☆
		6.00	0.4	CP-A1104-L5	☆	☆
		6.00	0.8	CP-A1108-L5	☆	☆
		6.00	0.8	CP-A1108-L5W	☆	☆

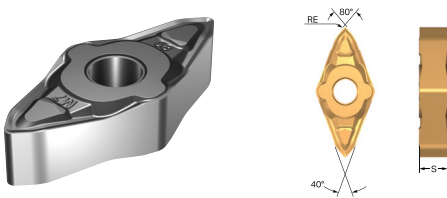

B-type insert

						M	S	
Medium	SSC	S	RE	BS	BSR	ISO CODE	1210	1210
	CP-B12..D	6.00	0.8			CP-B1208D-M5	☆	★
		6.00	0.8	0.7	15.0	CP-B1208D-M5W	☆	★
		6.00	0.8			CP-B1208D-M7	☆	★
		6.00	1.6			CP-B1216D-M7	☆	★
		6.00	0.8			CP-B1208D-M7W	☆	★

CoroTurn® TR insert for turning

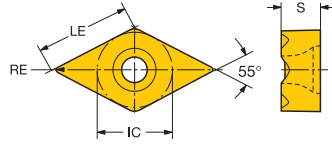
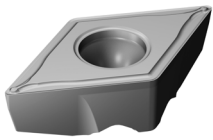

					P	M	S	
Finishing	F		LE	S	RE	1205	1205	1205
						☆	☆	★
		ISO CODE						
		13	12.6	5.53	0.40	☆	☆	★
			.496	.218	.016			
		12.2	5.53	0.79		☆	☆	★
			.480	.218	.031			
		12.6	4.53	0.40		☆	☆	★
			.496	.178	.016			
		12.2	4.53	0.79		☆	☆	★
			.480	.178	.031			

CoroTurn® 107 insert for turning

C-style insert (Rhombic 80°)

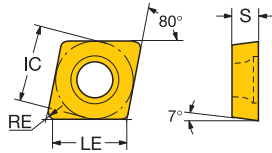
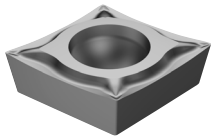

	LE	S	RE	ISO CODE	P M S					
					1205	1205	1205	1210		
Finishing	06 1/4	6.2	2.38	0.2	CCMT 06 02 02-MF	☆	☆	★		
		.246	.094	.008						
	6.0	2.38	0.4	CCMT 06 02 04-MF	☆	☆	★			
	.238	.094	.016							
	09 3/8	9.5	3.97	0.2	CCMT 09 T3 02-MF	☆	☆	★		
		.373	.156	.008						
		9.3	3.97	0.4	CCMT 09 T3 04-MF	☆	☆	★		
		.365	.156	.016						
	8.9	3.97	0.8	CCMT 09 T3 08-MF	☆	☆	★			
	.349	.156	.031							
	Medium	06 1/4	6.2	2.38	0.2	CCGX 06 02 02-AL		☆	★	
			.246	.094	.008					
6.0		2.38	0.4	CCGX 06 02 04-AL		☆	★			
.238		.094	.016							
6.0		2.38	0.4	CCMT 06 02 04-MM	☆	☆	★			
.238		.094	.016							
5.6		2.38	0.8	CCMT 06 02 08-MM	☆	☆	★			
.222		.094	.031							
6.3		2.38	0.1	CCET 06 02 01-UM	☆	☆	★			
.250		.094	.004							
6.2		2.38	0.2	CCET 06 02 02-UM	☆	☆	★			
.246		.094	.008							
6.0		2.38	0.4	CCET 06 02 04-UM	☆	☆	★			
.238		.094	.016							
6.3		2.38	0.1	CCGT 06 02 01-UM	☆	☆	★			
.250		.094	.004							
6.2		2.38	0.2	CCGT 06 02 02-UM	☆	☆	★			
.246		.094	.008							
6.0		2.38	0.4	CCGT 06 02 04-UM	☆	☆	★			
.238		.094	.016							
09 3/8		9.3	3.97	0.4	CCGX 09 T3 04-AL		☆	★		
		.365	.156	.016						
		8.9	3.97	0.8	CCGX 09 T3 08-AL		☆	★		
		.349	.156	.031						
		9.3	3.97	0.4	CCMT 09 T3 04-MM	☆	☆	★		
		.365	.156	.016						
		8.9	3.97	0.8	CCMT 09 T3 08-MM	☆	☆	★		
		.349	.156	.031						
		9.3	3.97	0.4	CCMT 09 T3 04-SMC				★	
		.365	.156	.016						
	8.9	3.97	0.8	CCMT 09 T3 08-SMC				★		
	.349	.156	.031							
	9.6	3.97	0.1	CCGT 09 T3 01-UM	☆	☆	★			
	.377	.156	.004							
	9.5	3.97	0.2	CCGT 09 T3 02-UM	☆	☆	★			
	.373	.156	.008							
	9.3	3.97	0.4	CCGT 09 T3 04-UM	☆	☆	★			
	.365	.156	.016							
8.9	3.97	0.8	CCGT 09 T3 08-UM	☆	☆	★				
.349	.156	.031								
12 1/2	12.5	4.76	0.4	CCMT 12 04 04-MM	☆	☆	★			
	.492	.188	.016							
	12.1	4.76	0.8	CCMT 12 04 08-MM	☆	☆	★			
.476	.188	.031								

CoroTurn® 107 insert for turning

D-style insert (Rhombic 55°)

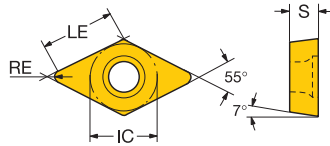
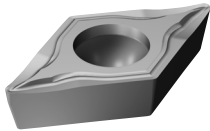

		LE	S	RE	ISO CODE	P M S					
						1205	1205	1205	1210		
Finishing	MF	07 1/4	7.6	2.38	0.20	DCMT 07 02 02-MF	☆	☆	★		
			.297	.094	.008						
			7.4	2.38	0.40	DCMT 07 02 04-MF	☆	☆	★		
			.289	.094	.016						
		11 3/8	11.4	3.97	0.20	DCMT 11 T3 02-MF	☆	☆	★		
			.450	.156	.008						
		11.2	3.97	0.40	DCMT 11 T3 04-MF	☆	☆	★			
		.442	.156	.016							
		10.8	3.97	0.79	DCMT 11 T3 08-MF	☆	☆	★			
		.426	.156	.031							
		11 3/8	11.2	3.97	0.40	DCMT 11 T3 04-SMC				★	
		.442	.156	.016							
	10.8	3.97	0.79	DCMT 11 T3 08-SMC				★			
	.426	.156	.031								
	10.4	3.97	1.19	DCMT 11 T3 12-SMC				★			
	.411	.156	.047								
Medium	MM	07 1/4	7.4	2.38	0.40	DCMT 07 02 04-MM	☆	☆	★		
			.289	.094	.016						
			7.0	2.38	0.79	DCMT 07 02 08-MM	☆	☆	★		
			.274	.094	.031						
		11 3/8	11.2	3.97	0.40	DCMT 11 T3 04-MM	☆	☆	★		
			.442	.156	.016						
		10.8	3.97	0.79	DCMT 11 T3 08-MM	☆	☆	★			
		.426	.156	.031							
	UM	UM	07 1/4	7.7	2.38	0.10	DCGT 07 02 01-UM	☆	☆	★	
				.301	.094	.004					
				7.6	2.38	0.20	DCGT 07 02 02-UM	☆	☆	★	
				.297	.094	.008					
			7.4	2.38	0.40	DCGT 07 02 04-UM	☆	☆	★		
			.289	.094	.016						
		7.0	2.38	0.79	DCGT 07 02 08-UM	☆	☆	★			
		.274	.094	.031							
AL		AL	07 1/4	7.6	2.38	0.20	DCGX 07 02 02-AL		☆	★	
				.297	.094	.008					
				7.4	2.38	0.40	DCGX 07 02 04-AL		☆	★	
				.289	.094	.016					
	11 3/8		11.4	3.97	0.20	DCGX 11 T3 02-AL		☆	★		
			.450	.156	.008						
	11.2	3.97	0.40	DCGX 11 T3 04-AL		☆	★				
	.442	.156	.016								
	10.8	3.97	0.79	DCGX 11 T3 08-AL		☆	★				
	.426	.156	.031								
UM	UM	11 3/8	11.4	3.97	0.20	DCGT 11 T3 02-UM	☆	☆	★		
			.450	.156	.008						
		07 1/4	7.7	2.38	0.05	DCET 07 02 00-UM	☆	☆	★		
			.303	.094	.002						
			7.7	2.38	0.10	DCET 07 02 01-UM	☆	☆	★		
			.301	.094	.004						
	UM	UM	11 3/8	11.5	3.97	0.10	DCET 11 T3 01-UM	☆	☆	★	
				.454	.156	.004					
				11.2	3.97	0.40	DCET 11 T3 04-UM	☆	☆	★	
				.442	.156	.016					
				10.8	3.97	0.79	DCET 11 T3 08-UM	☆	☆	★	
				.426	.156	.031					

CoroTurn® 107 insert for turning

R-style insert (Round)

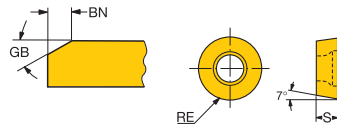
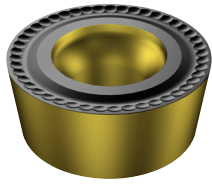

									P	K
		S	RE	GB	BN	ISO CODE	4415	4415		
Medium	M0	20	.787	6.35	10.00	15°	0.15	RCMT 20 06 M0	★	★
				.250	.394	15°	.006			
		25	.984	7.94	12.50	15°	0.20	RCMT 25 07 M0	★	★
				.313	.492	15°	.008			
	00	19	3/4	6.35	9.53	15°	0.15	RCMT 19 06 00	★	★
				.250	.375	15°	.006			

CoroTurn® 107 insert for turning

R-style insert (Round)

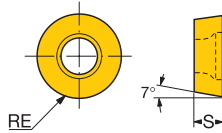
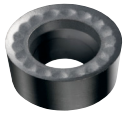

		S	RE	GB	BN	ISO CODE	P		M		S			
							1205	1205	1210	1210	1205	1210		
Finishing	L3	08	.315	3.18	4.00	RCMT 08 03 MP-L3	☆	☆			★			
			.125	.157										
		10	.394	3.97	5.00	RCMT 10 T3 MP-L3	☆	☆			★			
			.156	.197										
		12	.472	4.76	6.00	RCMT 12 04 MP-L3	☆	☆			★			
	.188	.236												
	16	.630	6.35	8.00	RCMT 16 06 MP-L3	☆	☆			★				
		.250	.315											
Medium	M3	08	.315	3.18	4.00	RCMT 08 03 MP-M3	☆	☆			★			
			.125	.157										
		10	.394	3.97	5.00	RCMT 10 T3 MP-M3	☆	☆			★			
			.156	.197										
		12	.472	4.76	6.00	RCMT 12 04 MP-M3	☆	☆			★			
		.188	.236											
		16	.630	6.35	8.00	RCMT 16 06 MP-M3	☆	☆			★			
			.250	.315										
		M0	05	.197	2.38	2.50	0.10	RCMT 05 02 M0	☆	☆	☆	★	☆	
			.094	.098	.004									
			06	.236	2.38	3.00	0.10	RCMT 06 02 M0	☆	☆		★		
				.094	.118	.004								
		SM	06	1/4	3.18	3.18		RCMT 06 03 00-SM			☆		★	
				.125	.125									
				08	.315	3.18	4.00		RCMT 08 03 M0-SM	☆	☆	☆	★	☆
					.125	.157								
			09	3/8	3.97	4.76	0.10	RCMT 09 T3 00-SM			☆		★	
				.156	.188	.004								
			10	.394	3.97	5.00	0.10	RCMT 10 T3 M0-SM	☆	☆	☆	★	☆	
			.156	.197	.004									
		12	.472	4.76	6.00	0.10	RCMT 12 04 M0-SM	☆	☆	☆	★	☆		
			.188	.236	.004									
			1/2	4.76	6.35	0.10	RCMT 12 04 00-SM	☆	☆	☆	★	☆		
			.188	.250	.004									
		16	.630	6.35	8.00	0.10	RCMT 16 06 M0-SM	☆	☆	☆	★	☆		
			.250	.315	.004									
	AL	10	.394	3.97	5.00		RCGX 10 T3 M0-AL		☆		★			
				.156	.197									
		12	.472	4.76	6.00		RCGX 12 04 M0-AL		☆		★			
			.188	.236										
Roughing	H7	08	.315	3.18	4.00		RCMT 08 03 MP-H7	☆	☆		★			
			.125	.157										
		10	.394	3.97	5.00		RCMT 10 T3 MP-H7	☆	☆		★			
			.156	.197										
		12	.472	4.76	6.00		RCMT 12 04 MP-H7	☆	☆		★			
	.188	.236												
	16	.630	6.35	8.00		RCMT 16 06 MP-H7	☆	☆		★				
		.250	.315											

CoroTurn® 107 insert for turning

S-style insert (Square)

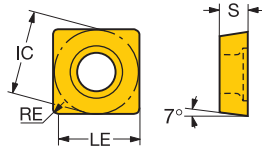
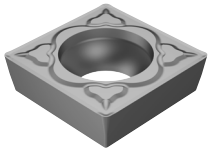

		IC	LE	S	RE	ISO CODE	P		M		S	
							1205	1205	1205	1210		
Medium	SMC	09	3/8	9.1	3.97	0.40	SCMT 09 T3 04-SMC					★
				.359	.156	.016						
				8.7	3.97	0.79	SCMT 09 T3 08-SMC					★
				.344	.156	.031						
	MM	09	3/8	9.1	3.97	0.40	SCMT 09 T3 04-MM	☆	☆	★		
				.359	.156	.016						
			8.7	3.97	0.79	SCMT 09 T3 08-MM	☆	☆	★			
			.344	.156	.031							

CoroTurn® 107 insert for turning

S-style insert (Square)

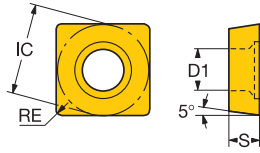
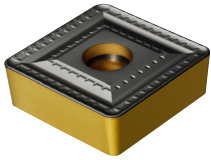

					ISO CODE	<div style="display: flex; justify-content: space-around;"> P K </div>			
		LE	S	RE		4415	4415		
Roughing	XH	38	1 1/2	34.9	12.70	3.18	SBMT 38 12 32-XH	★	★
				1.374	.500	.125			

CoroTurn® 107 insert for turning

T-style insert (Triangular)

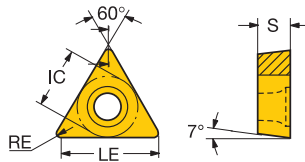
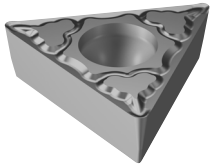

		LE	S	RE	ISO CODE	P	M	S			
						1205	1205	1205			
Finishing	MF	06	5/32	6.4	1.98	0.20	TCMT 06 T1 02-MF	☆	☆	★	
				.253	.078	.008					
				6.2	1.98	0.40	TCMT 06 T1 04-MF	☆	☆	★	
				.245	.078	.016					
				5.8	1.98	0.79	TCMT 06 T1 08-MF	☆	☆	★	
				.229	.078	.031					
			09	7/32	9.2	2.38	0.20	TCMT 09 02 02-MF	☆	☆	★
					.361	.094	.008				
					9.0	2.38	0.40	TCMT 09 02 04-MF	☆	☆	★
				.353	.094	.016					
		11	1/4	10.5	3.18	0.20	TCMT 11 03 02-MF	☆	☆	★	
				.415	.125	.008					
				10.3	3.18	0.40	TCMT 11 03 04-MF	☆	☆	★	
				.407	.125	.016					
		F	05	1/8	5.6	1.40	0.02	TCEX 05 01 00L-F	☆	☆	★
					.219	.055	.001				
					5.5	1.40	0.10	TCEX 05 01 01R/L-F	☆	☆	★
					.215	.055	.004				
	06		5/32	6.5	1.98	0.10	TCEX 06 T1 01L-F	☆	☆	★	
				.257	.078	.004					
				6.4	1.98	0.20	TCEX 06 T1 02L-F	☆	☆	★	
				.253	.078	.008					
			09	7/32	9.2	2.38	0.20	TCEX 09 02 02L-F	☆	☆	★
			.361	.094	.008						
		11	1/4	10.6	3.18	0.10	TCEX 11 03 01L-F	☆	☆	★	
			.419	.125	.004						
Medium	MM	09	7/32	9.0	2.38	0.40	TCMT 09 02 04-MM	☆	☆	★	
				.353	.094	.016					
				8.6	2.38	0.79	TCMT 09 02 08-MM	☆	☆	★	
				.337	.094	.031					
			11	1/4	10.3	3.18	0.40	TCMT 11 03 04-MM	☆	☆	★
					.407	.125	.016				
				9.9	3.18	0.79	TCMT 11 03 08-MM	☆	☆	★	
				.391	.125	.031					
		16	3/8	16.1	3.97	0.40	TCMT 16 T3 04-MM	☆	☆	★	
				.634	.156	.016					
				15.7	3.97	0.79	TCMT 16 T3 08-MM	☆	☆	★	
				.618	.156	.031					
	UM	16	3/8	16.1	3.97	0.40	TCGT 16 T3 04-UM	☆	☆	★	
			.634	.156	.016						
			15.7	3.97	0.79	TCGT 16 T3 08-UM	☆	☆	★		
			.618	.156	.031						

CoroTurn® 107 insert for turning

V-style insert (Rhombic 35°)

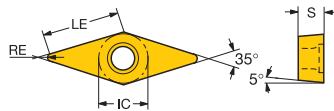
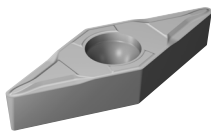

		LE	S	RE	ISO CODE	P	M	S					
						1205	1205	1205		1210			
Finishing	MF	11	1/4	10.9	3.18	0.20	VBMT 11 03 02-MF	☆	☆	★			
				.428	.125	.008							
				10.7	3.18	0.40	VBMT 11 03 04-MF	☆	☆	★			
				.420	.125	.016							
				10.3	3.18	0.79	VBMT 11 03 08-MF	☆	☆	★			
				.404	.125	.031							
		F	16	3/8	16.4	4.76	0.20	VBMT 16 04 02-MF	☆	☆	★		
				.646	.188	.008							
				16.2	4.76	0.40	VBMT 16 04 04-MF	☆	☆	★			
				.638	.188	.016							
				15.8	4.76	0.79	VBMT 16 04 08-MF	☆	☆	★			
				.622	.188	.031							
Medium	SMC	11	1/4	11.1	3.18	0.02	VCEX 11 03 00R/L-F	☆	☆	★			
				.436	.125	.001							
				11.0	3.18	0.10	VCEX 11 03 01R/L-F	☆	☆	★			
				.432	.125	.004							
		MM	16	3/8	16.2	4.76	0.40	VBMT 16 04 04-SMC				★	
				.638	.188	.016							
				15.8	4.76	0.79	VBMT 16 04 08-SMC					★	
				.622	.188	.031							
		UM	16	3/8	16.4	4.76	0.20	VBMT 16 04 12-SMC				★	
				.607	.188	.047							
			MM	16	3/8	16.2	4.76	0.40	VBMT 16 04 04-MM	☆	☆	★	
					.638	.188	.016						
				15.8	4.76	0.79	VBMT 16 04 08-MM	☆	☆	★			
				.622	.188	.031							
		UM	16	3/8	16.5	4.76	0.10	VBGT 16 04 01-UM	☆	☆	★		
				.650	.188	.004							
				16.4	4.76	0.20	VBGT 16 04 02-UM	☆	☆	★			
				.646	.188	.008							
				16.2	4.76	0.40	VBGT 16 04 04-UM	☆	☆	★			
				.638	.188	.016							
				15.8	4.76	0.79	VBGT 16 04 08-UM	☆	☆	★			
				.622	.188	.031							
		AL	11	1/4	10.7	3.18	0.40	VCGX 11 03 04-AL		☆	★		
				.420	.125	.016							
	16		3/8	16.2	4.76	0.40	VCGX 16 04 04-AL		☆	★			
			.638	.188	.016								
	UM	15.8	4.76	0.79	VCGX 16 04 08-AL		☆	★					
			.622	.188	.031								
		11	1/4	11.0	3.18	0.10	VCET 11 03 01-UM	☆	☆	★			
			.432	.125	.004								
	UM	10.9	3.18	0.20	VCET 11 03 02-UM	☆	☆	★					
			.428	.125	.008								

T-Max® P insert for turning

C-style insert (Rhombic 80°)

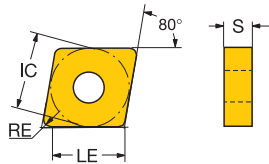
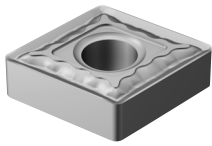

		LE	S	RE	ISO CODE	P		M		S		
						1205	1205	1210	1205	1210		
Finishing	MF	12	1/2	12.5	4.76	0.40	CNMG 12 04 04-MF	☆	☆		★	
				.492	.188	.016						
				12.1	4.76	0.79	CNMG 12 04 08-MF	☆	☆		★	
				.476	.188	.031						
				11.7	4.76	1.19	CNMG 12 04 12-MF	☆	☆		★	
				.460	.188	.047						
	SGF	12	1/2	12.8	4.76	0.10	CNGG 12 04 01-SGF		☆		★	
				.503	.188	.004						
				12.7	4.76	0.20	CNGG 12 04 02-SGF		☆		★	
				.498	.188	.008						
				8.5	4.76	0.40	CNGG 12 04 04-SGF		☆		★	
				.335	.188	.016						
SF	12	1/2	8.5	4.76	0.40	CNMG 12 04 04-SF		☆		★		
			.335	.188	.016							
			8.5	4.76	0.79	CNMG 12 04 08-SF		☆		★		
			.335	.188	.031							
			8.5	4.76	1.19	CNMG 12 04 12-SF		☆		★		
			.335	.188	.047							
Medium	SM	12	1/2	2.4	4.76	0.80	CNMX 12 04 A1-SM	☆	☆	☆	★	☆
				.094	.188	.031						
				3.8	4.76	0.80	CNMX 12 04 A2-SM	☆	☆	☆	★	☆
	SMC	12	1/2	12.5	4.76	0.40	CNMG 12 04 04-SMC					★
				.492	.188	.016						
				12.1	4.76	0.79	CNMG 12 04 08-SMC					★
				.476	.188	.031						
				11.7	4.76	1.19	CNMG 12 04 12-SMC					★
				.460	.188	.047						
	QM	16	5/8	15.3	6.35	0.79	CNMG 16 06 08-SMC					★
				.603	.250	.031						
				14.9	6.35	1.19	CNMG 16 06 12-SMC					★
				.587	.250	.047						
		12	1/2	12.5	4.76	0.40	CNMG 12 04 04-QM	☆	☆	☆	★	☆
				.492	.188	.016						
				12.1	4.76	0.79	CNMG 12 04 08-QM	☆	☆	☆	★	☆
				.476	.188	.031						
				11.7	4.76	1.19	CNMG 12 04 12-QM	☆	☆	☆	★	☆
SMR	12	1/2	8.5	4.76	0.79	CNMG 12 04 08-SMR			☆		★	
			.335	.188	.031							
			8.5	4.76	1.19	CNMG 12 04 12-SMR			☆		★	
			.335	.188	.047							
			8.5	4.76	1.59	CNMG 12 04 16-SMR			☆		★	
			.335	.188	.063							
Roughing	SMR	16	5/8	10.6	6.35	1.59	CNMG 16 06 16-SMR			☆		★
				.417	.250	.063						
	19	3/4	18.1	6.35	1.19	CNMG 19 06 12-SMR			☆		★	
			.714	.250	.047							

T-Max® P insert for turning

C-style insert (Rhombic 80°)

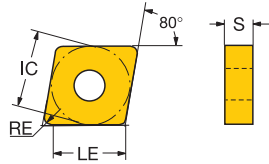
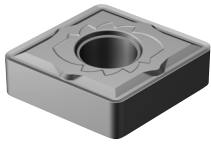

		LE	S	RE	ISO CODE	M		S		
						1205	1210	1205	1210	
Medium SM	12 1/2	8.5	4.76	0.40	CNMG 12 04 04-SM	☆	☆	★	☆	
		.335	.188	.016						
		8.5	4.76	0.79	CNMG 12 04 08-SM	☆	☆	★	☆	
		.335	.188	.031						
		8.5	4.76	1.19	CNMG 12 04 12-SM	☆	☆	★	☆	
		.335	.188	.047						
	16 5/8	15.3	6.35	0.79	CNMG 16 06 08-SM	☆	☆	★	☆	
		.603	.250	.031						
		10.6	6.35	1.19	CNMG 16 06 12-SM	☆	☆	★	☆	
		.417	.250	.047						
	10.6	6.35	1.59	CNMG 16 06 16-SM	☆	☆	★	☆		
		.417	.250	.063						
		19 3/4	18.5	6.35	0.79	CNMG 19 06 08-SM	☆	☆	★	☆
			.730	.250	.031					
		18.1	6.35	1.19	CNMG 19 06 12-SM	☆	☆	★	☆	
		.714	.250	.047						
	12.7	6.35	1.59	CNMG 19 06 16-SM	☆	☆	★	☆		
	.500	.250	.063							

T-Max® P insert for turning

C-style insert (Rhombic 80°)

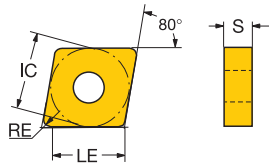
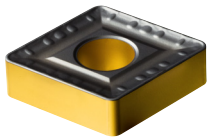

								P	K
		LE	S	RE	ISO CODE	4415	4415		
Finishing	PF	19	3/4	15.3	11.00	4.00	CNMX 19 11 40-PF	★	★
				.604	.433	.157			
Roughing	PR	25	1	23.4	9.53	2.38	CNMG 25 09 24-PR	★	★
				.921	.375	.094			
Roughing	HR	25	1	23.4	9.53	2.38	CNMM 25 09 24-HR	★	★
				.921	.375	.094			

T-Max® P insert for turning

D-style insert (Rhombic 55°)

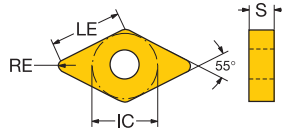
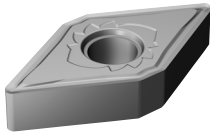

		LE	S	RE	ISO CODE	P		M		S				
						1205	1205	1210	1205	1210				
Finishing	MF	11	3/8	11.2	4.76	0.40	☆	☆			★			
				.442	.188	.016								
				10.8	4.76	0.79	DNMG 11 04 08-MF	☆	☆			★		
				.426	.188	.031								
			15	1/2	15.1	4.76	0.40	DNMG 15 04 04-MF	☆	☆			★	
				.595	.188	.016								
				14.7	4.76	0.79	DNMG 15 04 08-MF	☆	☆			★		
				.579	.188	.031								
				15.1	6.35	0.40	DNMG 15 06 04-MF	☆	☆			★		
				.595	.250	.016								
				14.7	6.35	0.79	DNMG 15 06 08-MF	☆	☆			★		
				.579	.250	.031								
			14.3	6.35	1.19	DNMG 15 06 12-MF	☆	☆			★			
			.563	.250	.047									
		SGF	15	1/2	13.6	4.76	0.10	DNMG 15 04 01-SGF	☆			★		
				.533	.188	.004								
				13.5	4.76	0.20	DNMG 15 04 02-SGF		☆			★		
				.530	.188	.008								
				6.4	4.76	0.40	DNMG 15 04 04-SGF		☆			★		
				.252	.188	.016								
				6.4	4.76	0.79	DNMG 15 04 08-SGF		☆			★		
				.252	.188	.031								
				6.4	4.76	1.19	DNMG 15 04 12-SGF		☆			★		
				.252	.188	.047								
			6.4	6.35	0.40	DNMG 15 06 04-SGF		☆			★			
			.252	.250	.016									
	SF	11	3/8	11.2	4.76	0.40	DNMG 11 04 04-SF	☆			★			
			.442	.188	.016									
			10.8	4.76	0.79	DNMG 11 04 08-SF	☆				★			
			.426	.188	.031									
			15	1/2	6.4	4.76	0.40	DNMG 15 04 04-SF	☆			★		
			.252	.188	.016									
			6.4	4.76	0.79	DNMG 15 04 08-SF	☆				★			
			.252	.188	.031									
			6.4	4.76	1.19	DNMG 15 04 12-SF	☆				★			
			.252	.188	.047									
			6.4	6.35	0.40	DNMG 15 06 04-SF	☆				★			
			.252	.250	.016									
		6.4	6.35	0.79	DNMG 15 06 08-SF	☆				★				
		.252	.250	.031										
		6.4	6.35	1.19	DNMG 15 06 12-SF	☆				★				
		.252	.250	.047										

T-Max® P insert for turning

D-style insert (Rhombic 55°)

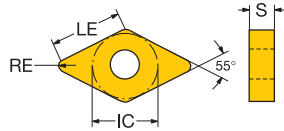
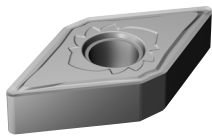

		LE	S	RE	ISO CODE	P		M		S			
						1205	1210	1205	1210	1205	1210		
Medium	SMC	11	3/8	10.8	4.76	0.79						★	
				.426	.188	.031							
		15	1/2	15.1	4.76	0.40							★
				.595	.188	.016							
				14.7	4.76	0.79							★
				.579	.188	.031							
				15.1	6.35	0.40							★
				.595	.250	.016							
				14.7	6.35	0.79							★
			.579	.250	.031								
			14.3	6.35	1.19							★	
			.563	.250	.047								
		QM	11	3/8	10.8	4.76	0.79			☆			★
				.426	.188	.031							
			15	1/2	15.1	4.76	0.40		☆	☆	☆	★	☆
				.595	.188	.016							
				14.7	4.76	0.79			☆	☆	☆	★	☆
				.579	.188	.031							
				14.3	4.76	1.19			☆	☆	☆	★	☆
				.563	.188	.047							
				15.1	6.35	0.40			☆	☆	☆	★	☆
			.595	.250	.016								
			14.7	6.35	0.79			☆	☆	☆	★	☆	
			.579	.250	.031								
		14.3	6.35	1.19			☆	☆	☆	★	☆		
		.563	.250	.047									
	SM	11	3/8	11.2	4.76	0.40		☆	☆	☆	★	☆	
			.442	.188	.016								
		15	1/2	6.4	4.76	0.40		☆	☆	★	☆		
			.252	.188	.016								
			6.4	4.76	0.79			☆	☆	★	☆		
			.252	.188	.031								
			6.4	4.76	1.19			☆	☆	★	☆		
			.252	.188	.047								
			6.4	6.35	0.40			☆	☆	★	☆		
		.252	.250	.016									
		6.4	6.35	0.79			☆	☆	★	☆			
		.252	.250	.031									
		6.4	6.35	1.19			☆	☆	★	☆			
		.252	.250	.047									
	SMR	15	1/2	6.4	4.76	0.79			☆			★	
			.252	.188	.031								
			6.4	4.76	1.19				☆			★	
			.252	.188	.047								
			6.4	6.35	0.79				☆			★	
			.252	.250	.031								
		6.4	6.35	1.19				☆			★		
		.252	.250	.047									
		6.4	6.35	1.59				☆			★		
		.252	.250	.063									

T-Max® P insert for turning

R-style insert (Round)

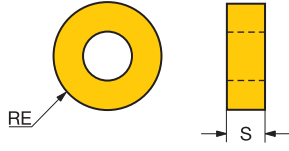
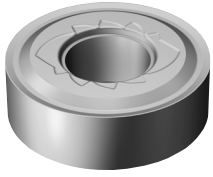

				S	RE	ISO CODE	M	S
Medium	SM	19	3/4	6.35	9.53	RNMG 19 06 00-SM	1210	1210
				.250	.375		☆	★

T-Max® P insert for turning

R-style insert (Round)

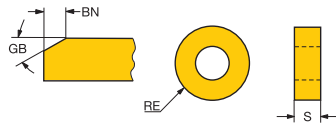

									P	K
		S	RE	GB	BN	ISO CODE	4415	4415		
Medium	00	20	.787	6.35	10.00	15°	0.30	RCMX 20 06 00	★	★
				.250	.394	15°	.012			
		25	.984	7.94	12.50	15°	0.40	RCMX 25 07 00	★	★
				.313	.492	15°	.016			
		19	3/4	6.35	9.53			RNMG 19 06 00	★	★
				.250	.375					

T-Max® P insert for turning

S-style insert (Square)

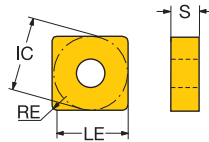
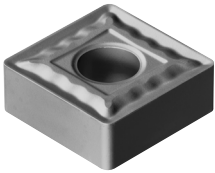

		LE	S	RE	ISO CODE	P		M		S				
						1205	1205	1210	1210	1205	1210			
Medium	SMC	12	1/2	12.3	4.76	0.40						★		
				.484	.188	.016								
				11.9	4.76	0.79							★	
	Medium	QM	12	1/2	11.9	4.76	0.79	☆	☆	☆	★	☆		
					.469	.188	.031							
					11.5	4.76	1.19		☆	☆	☆	★	☆	
					.453	.188	.047							
					11.1	4.76	1.59		☆	☆	☆	★	☆	
					.437	.188	.063							
		SM	15	5/8	14.7	6.35	1.19		☆	☆	☆	★	☆	
					.578	.250	.047							
					14.3	6.35	1.59		☆	☆	☆	★	☆	
				.562	.250	.063								
19			3/4	17.9	6.35	1.19		☆	☆	☆	★	☆		
				.703	.250	.047								
Medium	SM	12	1/2	12.3	4.76	0.40		☆	☆	★	☆			
				.484	.188	.016								
				8.5	4.76	0.79			☆	☆	★	☆		
				.335	.188	.031								
				8.5	4.76	1.19			☆	☆	★	☆		
				.335	.188	.047								
	SMR	15	5/8	15.1	6.35	0.79		☆	☆	★	☆			
				.594	.250	.031								
				10.6	6.35	1.19			☆	☆	★	☆		
				.417	.250	.047								
				10.6	6.35	1.59			☆	☆	★	☆		
				.417	.250	.063								
Roughing	SMR	12	1/2	8.5	4.76	0.79			☆		★			
				.335	.188	.031								
				8.5	4.76	1.19				☆		★		
				.335	.188	.047								
				8.5	4.76	1.59				☆		★		
				.335	.188	.063								
	SMR	15	5/8	10.6	6.35	1.59			☆		★			
				.417	.250	.063								
		19	3/4	17.9	6.35	1.19			☆		★			
				.703	.250	.047								
				12.7	6.35	1.59			☆		★			
				.500	.250	.063								

T-Max® P insert for turning

S-style insert (Square)

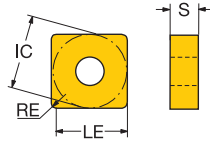
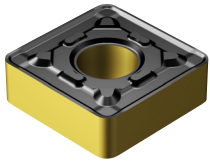

					ISO CODE	P	K		
		LE	S	RE		4415	4415		
Roughing	PR	25	1	23.0	7.94	2.38	SNMG 25 07 24-PR	★	★
				.906	.313	.094			
				23.0	9.53	2.38	SNMG 25 09 24-PR	★	★
				.906	.375	.094			
	QR	25	1	23.0	7.94	2.38	SNMM 25 07 24-QR	★	★
				.906	.313	.094			
	HR	25	1	23.0	7.94	2.38	SNMM 25 07 24-HR	★	★
				.906	.313	.094			
				22.2	7.94	3.18	SNMM 25 07 32-HR	★	★
				.874	.313	.125			
				23.0	9.53	2.38	SNMM 25 09 24-HR	★	★
				.906	.375	.094			
		22.2	9.53	3.18	SNMM 25 09 32-HR	★	★		
		.874	.375	.125					

T-Max® P insert for turning

T-style insert (Triangular)

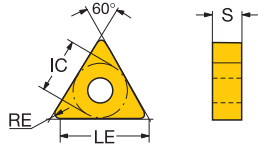
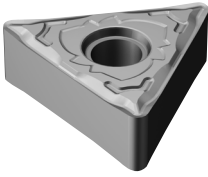

					ISO CODE	<table border="1"> <tr> <th>P</th> <th colspan="3">M</th> <th colspan="2">S</th> </tr> <tr> <th>1205</th> <th>1205</th> <th>1210</th> <th>1205</th> <th>1210</th> </tr> </table>					P	M			S		1205	1205	1210	1205	1210
		P	M			S															
1205	1205	1210	1205	1210																	
		LE	S	RE																	
Finishing	SF	16	3/8	4.8	4.76	0.40	TNMG 16 04 04-SF	☆			★										
				.189	.188	.016															
				4.8	4.76	0.79	TNMG 16 04 08-SF	☆			★										
				.189	.188	.031															
Medium	SMC	16	3/8	15.7	4.76	0.79	TNMG 16 04 08-SMC					★									
				.618	.188	.031															
	QM	16	3/8	15.7	4.76	0.79	TNMG 16 04 08-QM	☆	☆	☆	★	☆									
				.618	.188	.031															
				15.3	4.76	1.19	TNMG 16 04 12-QM	☆	☆	☆	★	☆									
				.602	.188	.047															
		22	1/2	20.4	4.76	1.59	TNMG 22 04 16-QM	☆	☆	☆	★	☆									
			.803	.188	.063																
	SM	16	3/8	16.1	4.76	0.40	TNMG 16 04 04-SM		☆	☆	★	☆									
				.634	.188	.016															
				4.8	4.76	0.79	TNMG 16 04 08-SM		☆	☆	★	☆									
				.189	.188	.031															
			4.8	4.76	1.19	TNMG 16 04 12-SM		☆	☆	★	☆										
			.189	.188	.047																
		22	1/2	6.4	4.76	0.79	TNMG 22 04 08-SM		☆	☆	★	☆									
			.252	.188	.031																
		6.4	4.76	1.19	TNMG 22 04 12-SM		☆	☆	★	☆											
		.252	.188	.047																	

T-Max® P insert for turning

V-style insert (Rhombic 35°)

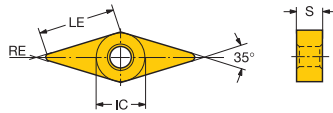
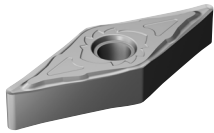

		LE	S	RE	ISO CODE	P		M		S			
						1205	1205	1210	1205	1210			
Finishing	MF	16	3/8	16.2	4.76	0.40	VNMG 16 04 04-MF	☆	☆		★		
				.638	.188	.016							
				15.8	4.76	0.79	VNMG 16 04 08-MF	☆	☆		★		
				.622	.188	.031							
		SGF	16	3/8	16.3	4.76	0.10	VNGG 16 04 01-SGF		☆		★	
					.640	.188	.004						
				16.1	4.76	0.20	VNGG 16 04 02-SGF		☆		★		
				.632	.188	.008							
				2.4	4.76	0.40	VNGG 16 04 04-SGF		☆		★		
				.094	.188	.016							
	SF	16	3/8	16.2	4.76	0.40	VNMG 16 04 04-SF		☆		★		
				.638	.188	.016							
			15.8	4.76	0.79	VNMG 16 04 08-SF		☆		★			
			.622	.188	.031								
			15.4	4.76	1.19	VNMG 16 04 12-SF		☆		★			
			.607	.188	.047								
Medium	SMC	16	3/8	16.2	4.76	0.40	VNMG 16 04 04-SMC					★	
				.638	.188	.016							
				15.8	4.76	0.79	VNMG 16 04 08-SMC					★	
				.622	.188	.031							
	QM	16	3/8	16.2	4.76	0.40	VNMG 16 04 04-QM	☆	☆	☆	★	☆	
				.638	.188	.016							
				15.8	4.76	0.79	VNMG 16 04 08-QM	☆	☆	☆	★	☆	
				.622	.188	.031							
	SM	16	3/8	16.2	4.76	0.40	VNMG 16 04 04-SM		☆	☆	★	☆	
				.638	.188	.016							
				15.8	4.76	0.79	VNMG 16 04 08-SM		☆	☆	★	☆	
				.622	.188	.031							
		15.4	4.76	1.19	VNMG 16 04 12-SM		☆	☆	★	☆			
		.607	.188	.047									

T-Max® P insert for turning

W-style insert (Trigon 80°)

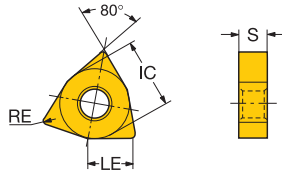
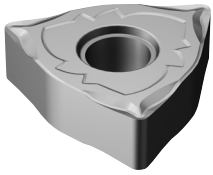

					ISO CODE	P		M		S			
		LE	S	RE		1205	1205	1210	1205	1210			
Finishing	MF	08	1/2	7.9	4.76	0.79	WNMG 08 04 08-MF	☆			★		
				.311	.188	.031							
	SGF	08	1/2	7.5	4.76	0.20	WNGG 08 04 02-SGF		☆			★	
				.294	.188	.008							
				3.2	4.76	0.40	WNGG 08 04 04-SGF		☆			★	
				.126	.188	.016							
	SF	08	1/2	3.2	4.76	0.40	WNMG 08 04 04-SF		☆			★	
				.126	.188	.016							
				7.9	4.76	0.79	WNMG 08 04 08-SF		☆			★	
				.311	.188	.031							
	Medium	SMC	08	1/2	8.3	4.76	0.40	WNMG 08 04 04-SMC					★
					.326	.188	.016						
				7.9	4.76	0.79	WNMG 08 04 08-SMC					★	
				.311	.188	.031							
QM		06	3/8	5.7	4.76	0.79	WNMG 06 04 08-QM			☆		★	
				.225	.188	.031							
		08	1/2	8.3	4.76	0.40	WNMG 08 04 04-QM	☆	☆	☆	★	☆	
				.326	.188	.016							
SM		06	3/8	6.1	4.76	0.40	WNMG 06 04 04-SM	☆	☆			★	
				.241	.188	.016							
				5.7	4.76	0.79	WNMG 06 04 08-SM	☆	☆			★	
				.225	.188	.031							
SMR	08	1/2	3.2	4.76	0.40	WNMG 08 04 04-SM		☆	☆	★	☆		
			.126	.188	.016								
			7.9	4.76	0.79	WNMG 08 04 08-SM		☆	☆	★	☆		
			.311	.188	.031								
SMR	08	1/2	7.9	4.76	0.79	WNMG 08 04 08-SMR			☆		★		
			.311	.188	.031								
			7.5	4.76	1.19	WNMG 08 04 12-SMR			☆		★		
		.295	.188	.047									

T-Max® P insert for turning

Insert for railway wheel re-turning

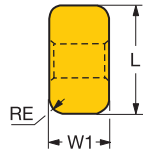
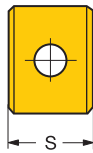

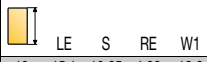
							ISO CODE	P
Finishing	PF	19	15.1	19.05	4.00	10.0	LNUX 19 19 40-PF	★
			.593	.750	.157	.394		
Medium	PM	19	15.1	19.05	4.00	10.0	LNMX 19 19 40-PM	★
			.593	.750	.157	.394		
		30	26.0	19.05	4.00	12.0	LNMX 30 19 40-PM	★
			1.024	.750	.157	.472		
Roughing	XH	50	34.0	14.20	3.18	25.4	LNMX 50 14 32-XH	★
			1.339	.559	.125	1.000		
	PR	32		12.70	4.75	19.1	LNUX 32 12 48-PR	★
				.500	.187	.750		
	PR	30	26.0	19.05	4.00	12.0	LNUX 30 19 40-PR	★
				1.024	.750	.157		
	PR	26.0	19.05	4.00	12.0	LNMX 30 19 40-PR	★	
			1.024	.750	.157			.472

T-Max® insert for turning

R-style insert (Round)

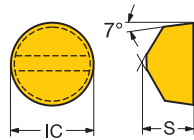

								S	
		IC	S	RE	ISO CODE			6.60	
Medium	SM	12	1/2	7.94	6.35	RCMX120700-SM			★
				.313	.250				

CoroTurn® TR cutting unit for turning

Screw clamp design



TR-VB

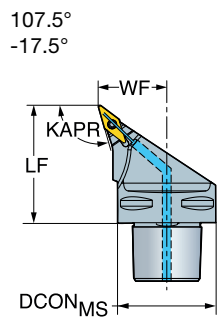
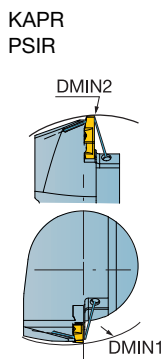

							Dimensions, mm, inch							MIID
	CZC _{MS}	DMIN ₁	DMIN ₂	RMPX	CNSC	Ordering code	DCON _{MS}	LF	WF	BAR PSI	NM	KG		
	13	C4	110.0	140.0	35°	3	C4-TR-V13HBR/L-27050C1	40	50.0	27.0	150	2.0	0.35	TR-VB1308
			4.331	5.512					1.575	1.969	1.063	2175		
	C5	115.0	165.0	35°	3	C5-TR-V13HBR/L-35060C1	50	60.0	35.0	150	2.0	0.63	TR-VB1308	
		4.528	6.496					1.969	2.362	1.378	2175			
	C6	120.0	190.0	35°	3	C6-TR-V13HBR/L-45065C1	63	65.0	45.0	150	2.0	1.12	TR-VB1308	
		4.724	7.480					2.480	2.559	1.772	2175			
	C8	125.0	250.0	35°	3	C8-TR-V13HBR/L-55080C1	80	80.0	55.0	150	2.0	2.46	TR-VB1308	
		4.921	9.843					3.150	3.150	2.165	2175			

R = Right hand, L = Left hand

CoroTurn® TR cutting unit for turning

Screw clamp design



TR-VB



KAPR
PSIR

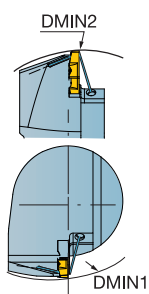

93.0°
-3.0°

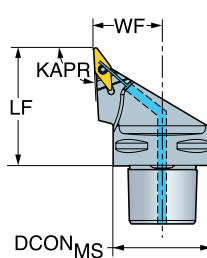

							Dimensions, mm, inch						MID	
	CZC _{MS}	DMIN ₁	DMIN ₂	RMPX	CNSC	Ordering code	DCON _{MS}	LF	WF	BAR PSI	NM	KG		
	13	C4	130.0	140.0	50°	3	C4-TR-V13JBR/L-27050C1	40	50.0	27.0	150	2.0	0.33	TR-VB1308
			5.118	5.512					1.575	1.969	1.063	2175		
	C5	130.0	165.0	50°	3	C5-TR-V13JBR/L-35060C1	50	60.0	35.0	150	2.0	0.61	TR-VB1308	
		5.118	6.496					1.969	2.362	1.378	2175			
	C6	130.0	190.0	50°	3	C6-TR-V13JBR/L-45065C1	63	65.0	45.0	150	2.0	1.02	TR-VB1308	
		5.118	7.480					2.480	2.559	1.772	2175			
	C8	140.0	250.0	50°	3	C8-TR-V13JBR/L-55080C1	80	80.0	55.0	150	2.0	2.35	TR-VB1308	
		5.512	9.843					3.150	3.150	2.165	2175			

R = Right hand, L = Left hand

CoroTurn® TR cutting unit for turning

Screw clamp design

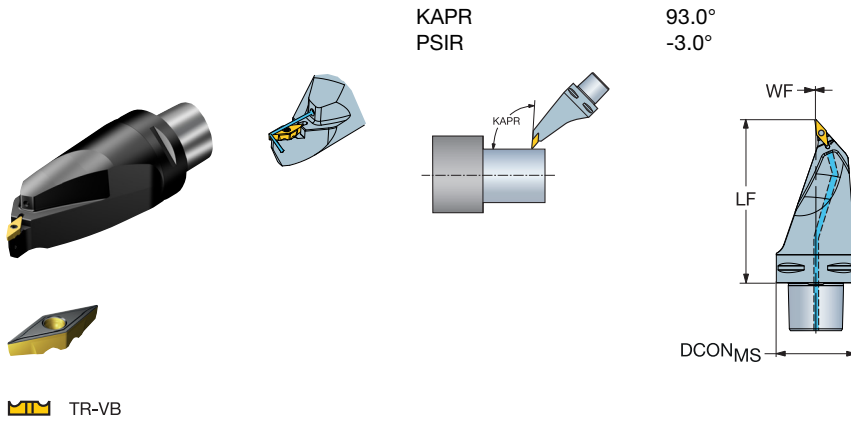

				Dimensions, mm, inch								
		CZCMS	RMPX	CNCS	Ordering code	DCONMS	LF	WF				MIID
		C6	50°	3	C6-TR-V13MBL-00130C1	63	130.0	0.0	150	2.0	1.99	TR-VB1308
		C8	50°	3	C8-TR-V13MBL-00160C1	80	160.0	0.0	150	2.0	4.05	TR-VB1308
						3.150	6.299	.000	2175			

R = Right hand, L = Left hand

CoroTurn® TR cutting unit for turning

Screw clamp design



TR-VB



KAPR
PSIR

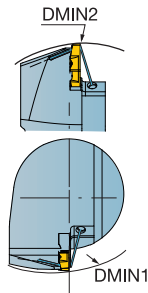

93.0°
-3.0°

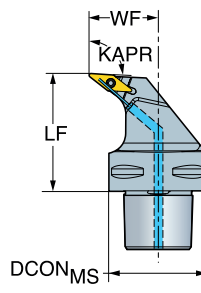

	CZC _{MS}	DMIN ₁	DMIN ₂	RMPX	CNCS	Ordering code	Dimensions, mm, inch						MID	
							DCON _{MS}	LF	WF	BAR PSI	NM	KG		
	13	C4	55.0	140.0	50°	3	C4-TR-V13UBR/L-27050C1	40	50.0	27.0	150	2.0	0.37	TR-VB1308
			2.165	5.512					1.575	1.969	1.063	2175		
	C5	65.0	165.0	50°	3	C5-TR-V13UBR/L-35060C1	50	60.0	35.0	150	2.0	0.68	TR-VB1308	
		2.559	6.496					1.969	2.362	1.378	2175			
	C6	85.0	190.0	50°	3	C6-TR-V13UBR/L-45065C1	63	65.0	45.0	150	2.0	1.20	TR-VB1308	
		3.346	7.480					2.480	2.559	1.772	2175			
C8	110.0	250.0	50°	3	C8-TR-V13UBR/L-55080C1	80	80.0	55.0	150	2.0	2.51	TR-VB1308		
		4.331	9.843				3.150	3.150	2.165	2175				

R = Right hand, L = Left hand

CoroTurn® TR cutting unit for turning

Screw clamp design

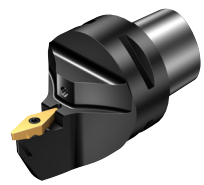

TR-VB



KAPR
PSIR

72.5°
17.5°

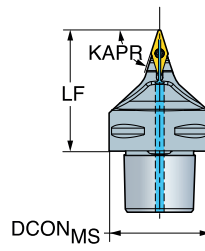
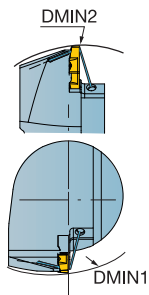

	CZC _{MS}	DMIN ₂	RMPX	CNCS	Ordering code	Dimensions, mm, inch						MID	
						DCON _{MS}	LF	WF	BAR PSI	NM	KG		
	13	C4	140.0	70°	3	C4-TR-V13VBN-00050C1	40	50.0	0.5	150	2.0	0.29	TR-VB1308
			5.512				1.575	1.969	.020	2175			
		C5	165.0	70°	3	C5-TR-V13VBN-00060C1	50	60.0	0.5	150	2.0	0.58	TR-VB1308
			6.496				1.969	2.362	.020	2175			
		C6	190.0	70°	3	C6-TR-V13VBN-00065C1	63	65.0	0.5	150	2.0	1.00	TR-VB1308
			7.480				2.480	2.559	.020	2175			

R = Right hand, L = Left hand

CoroTurn® TR cutting unit for turning

Screw clamp design

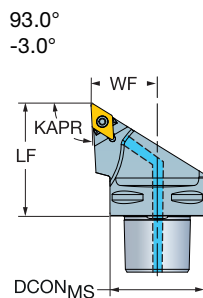
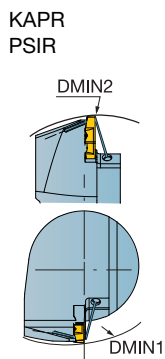

TR-DC

							Dimensions, mm, inch						MID
	13	CZC _{MS}	DMIN ₁	DMIN ₂	RMPX	CNSC	Ordering code	DCON _{MS}	LF	WF	BAR PSI	NM	
	C4	130.0	140.0	27°	3	C4-TR-D13JCR/L-27050C1	40	50.0	27.0	150	3.0	0.36	TR-DC1308
		5.118	5.512					1.575	1.969	1.063	2175		
	C5	130.0	165.0	27°	3	C5-TR-D13JCR/L-35060C1	50	60.0	35.0	150	3.0	0.67	TR-DC1308
		5.118	6.496					1.969	2.362	1.378	2175		
	C6	130.0	190.0	27°	3	C6-TR-D13JCR/L-45065C1	63	65.0	45.0	150	3.0	1.15	TR-DC1308
		5.118	7.480					2.480	2.559	1.772	2175		
	C8	145.0	250.0	27°	3	C8-TR-D13JCR/L-55080C1	80	80.0	55.0	150	3.0	2.35	TR-DC1308
		5.709	9.843					3.150	3.150	2.165	2175		

R = Right hand, L = Left hand

CoroTurn® TR cutting unit for turning

Screw clamp design

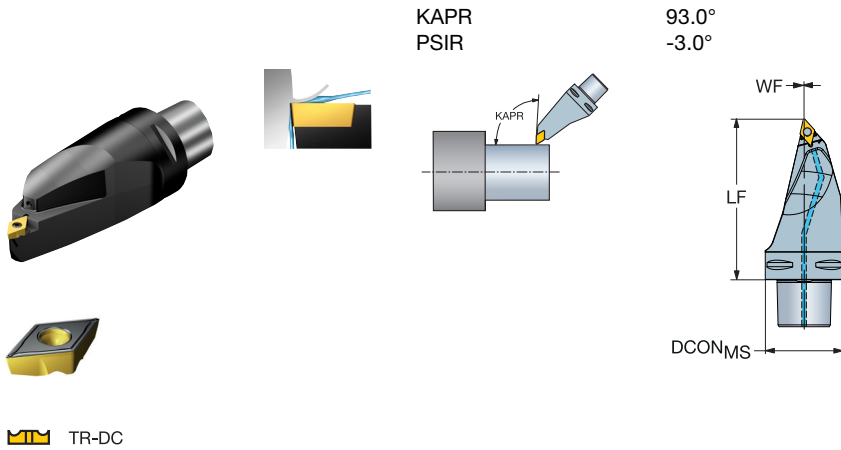

				Dimensions, mm, inch								
	CZC _{MS}	RMPX	CNSC	Ordering code	DCON _{MS}	LF	WF	BAR	NM	KG	MIID	
								PSI				
	13	C5	30°	3	C5-TR-D13MCL-00115C1	50	115.0	0.0	150	3.0	1.22	TR-DC1308
	C6	30°	3	C6-TR-D13MCL-00130C1	63	130.0	0.0	150	3.0	2.09	TR-DC1308	
	C8	30°	3	C8-TR-D13MCL-00160C1	80	160.0	0.0	150	3.0	4.29	TR-DC1308	

R = Right hand, L = Left hand

CoroTurn® TR cutting unit for turning

Screw clamp design





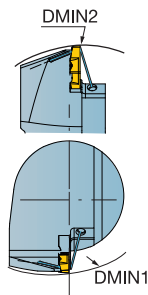

KAPR
PSIR

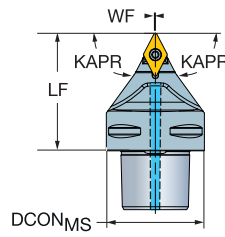

62.5°
27.5°

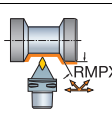

 TR-DC

						Dimensions, mm, inch							MIID
		CZC _{MS}	DMIN ₂	RMPX	CNSC	Ordering code	DCON _{MS}	LF	WF				
	13	C4	140.0	57°	3	C4-TR-D13NCN-00050C1	40	50.0	0.5	150	3.0	0.31	TR-DC1308
			5.512				1.575	1.969	.020	2175			
		C5	165.0	57°	3	C5-TR-D13NCN-00060C1	50	60.0	0.5	150	3.0	0.61	TR-DC1308
			6.496				1.969	2.362	.020	2175			
		C6	190.0	57°	3	C6-TR-D13NCN-00065C1	63	65.0	0.5	150	3.0	1.06	TR-DC1308
			7.480				2.480	2.559	.020	2175			

R = Right hand, L = Left hand

ENG

CoroTurn® 107 cutting unit for turning

Screw clamp design

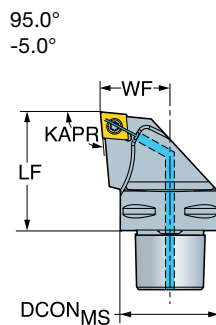
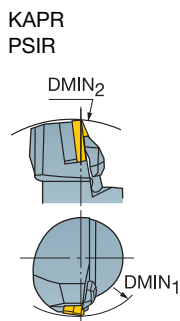
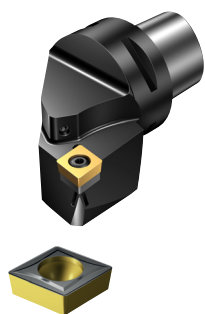

- CCMT, CCGT
CCGX, CCET
- CCMW

							Dimensions, mm, inch							MIID
			CZC _{MS}	DMIN ₁	DMIN ₂	CNSC	Ordering code	DCON _{MS}	LF	WF				
	09	3/8	C3	130.0	120.0	3	C3-SCLCR/L-22040-09C1	32	40.0	22.0	150	3.0	0.19	CCMT 09 T3 08
				5.118	4.724		1.260	1.575	.866	2175				
			C4	130.0	140.0	3	C4-SCLCR/L-27050-09C1	40	50.0	27.0	150	3.0	0.44	CCMT 09 T3 08
				5.118	5.512		1.575	1.969	1.063	2175				
	12	1/2	C4	125.0	140.0	3	C4-SCLCR/L-27050-12C1	40	50.0	27.0	150	3.0	0.44	CCMT 12 04 08
				4.921	5.512		1.575	1.969	1.063	2175				
		C5	125.0	165.0	3	C5-SCLCR/L-35060-12C1	50	60.0	35.0	150	3.0	0.76	CCMT 12 04 08	
			4.921	6.496		1.969	2.362	1.378	2175					
		C6	125.0	190.0	3	C6-SCLCR/L-45065-12C1	63	65.0	45.0	150	3.0	1.30	CCMT 12 04 08	
			4.921	7.480		2.480	2.559	1.772	2175					

R = Right hand, L = Left hand

CoroTurn® 107 cutting unit for turning

Screw clamp design

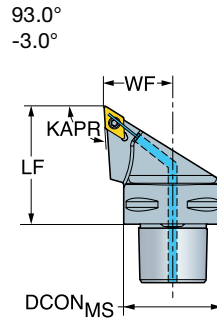
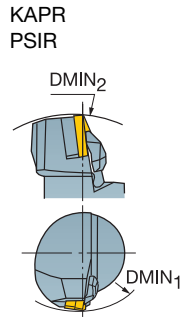

- DCMT, DCMX
DCGT, DCGX, DCET
- DCMW

								Dimensions, mm, inch							
	11	3/8	CZC _{MS}	DMIN ₁	DMIN ₂	RMPX	CNSC	Ordering code	DCON _{MS}	LF	WF	BAR PSI	NM	KG	MIID
			C3	140.0	120.0	27°	3	C3-SDJCR/L-22040-11C1	32	40.0	22.0	150	3.0	0.19	DCMT 11 T3 08
				5.512	4.724				1.260	1.575	.866	2175			
			C4	145.0	140.0	27°	3	C4-SDJCR/L-27050-11C1	40	50.0	27.0	150	3.0	0.38	DCMT 11 T3 08
				5.709	5.512				1.575	1.969	1.063	2175			
			C5	145.0	165.0	27°	3	C5-SDJCR/L-35060-11C1	50	60.0	35.0	150	3.0	0.70	DCMT 11 T3 08
				5.709	6.496				1.969	2.362	1.378	2175			
			C6	140.0	190.0	27°	3	C6-SDJCR/L-45065-11C1	63	65.0	45.0	150	3.0	1.18	DCMT 11 T3 08
				5.512	7.480				2.480	2.559	1.772	2175			





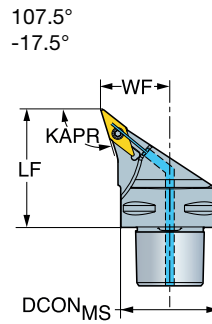
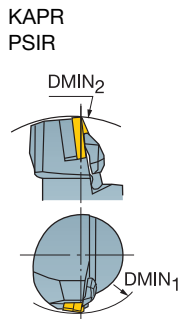

R = Right hand, L = Left hand

CoroTurn® 107 cutting unit for turning

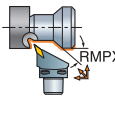
Screw clamp design



-  VBMT, VBGT
 VCGX,
 VCGT, VCET
 VBMT, VCMW

									Dimensions, mm, inch						
			CZC _{MS}	DMIN ₁	DMIN ₂	RMPX	CNSC	Ordering code	DCON _{MS}	LF	WF				MIID
		16	3/8	C4	95.0	140.0	35°	3	C4-SVHBR/L-27050-16C1	40	50.0	27.0	150	3.0	0.33
				3.740	5.512				1.575	1.969	1.063	2175			
			C5	95.0	165.0	35°	3	C5-SVHBR/L-35060-16C1	50	60.0	35.0	150	3.0	0.62	VBMT 16 04 08
				3.740	6.496				1.969	2.362	1.378	2175			
			C6	95.0	190.0	35°	3	C6-SVHBR/L-45065-16C1	63	65.0	45.0	150	3.0	1.11	VBMT 16 04 08
				3.740	7.480				2.480	2.559	1.772	2175			

R = Right hand, L = Left hand

CoroTurn® 107 cutting unit for turning

Screw clamp design



KAPR
PSIR

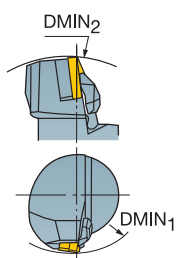

93.0°
-3.0°

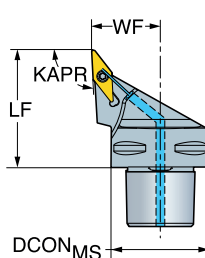

- VBMT, VBGT
VCGX,
VCGT, VCET
- VBMW, VCMW

								Dimensions, mm, inch							
		CZC _{MS}	DMIN ₁	DMIN ₂	RMPX	CNSC	Ordering code	DCON _{MS}	LF	WF				MIID	
	11	1/4	C3	105.0	120.0	50°	3	C3-SVJBR/L-2204011B1C1	32	40.0	22.0	150	0.9	0.21	VBMT 11 03 04
				4.134	4.724						1.260	1.575	.866	2175	
		C4	105.0	140.0	50°	3	C4-SVJBL-2705011B1C1	40	50.0	27.0	150	0.9	0.36	VBMT 11 03 04	
			4.134	5.512						1.575	1.969	1.063	2175		
	16	3/8	C4	105.0	140.0	50°	3	C4-SVJBR-2705011B1C1	40	50.0	27.0	150	3.0	0.36	VBMT 11 03 04
				4.134	5.512						1.575	1.969	1.063	2175	
		C4	155.0	140.0	50°	3	C4-SVJBR/L-27050-16C1	40	50.0	27.0	150	3.0	0.33	VBMT 16 04 08	
			6.102	5.512						1.575	1.969	1.063	2175		
C5	155.0	165.0	50°	3	C5-SVJBR/L-35060-16C1	50	60.0	35.0	150	3.0	0.63	VBMT 16 04 08			
	6.102	6.496						1.969	2.362	1.378	2175				
	C6	155.0	190.0	50°	3	C6-SVJBR/L-45065-16C1	63	65.0	45.0	150	3.0	1.11	VBMT 16 04 08		
		6.102	7.480						2.480	2.559	1.772	2175			
C8	220.0	250.0	50°	3	C8-SVJBR/L-55080-16C1	80	80.0	55.0	150	3.0	2.32	VBMT 16 04 08			
	8.661	9.843						3.150	3.150	2.165	2175				

R = Right hand, L = Left hand

CoroTurn® 107 cutting unit for turning

Screw clamp design



KAPR
PSIR

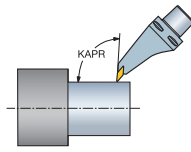

93.0°
-3.0°

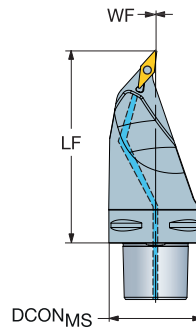

VBMT, VBGT
VCGX,
VCGT, VCET



VBMW, VCMW

						Dimensions, mm, inch							
		CZC _{MS}	RMPX	CNSC	Ordering code	DCON _{MS}	LF	WF	BAR PSI	NM	KG	MIID	
	16	3/8	C6	50°	3	C6-SVMBR/L-00130-16C1	63	130.0	0.0	150	3.0	2.10	VBMT 16 04 08
							2.480	5.118	.000	2175			
			C8	50°	3	C8-SVMBR/L-00160-16C1	80	160.0	0.0	150	3.0	4.25	VBMT 16 04 08
							3.150	6.299	.000	2175			

R = Right hand, L = Left hand

CoroTurn® 107 cutting unit for turning

Screw clamp design



KAPR
PSIR

72.5°
17.5°

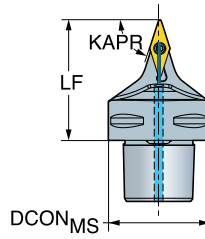
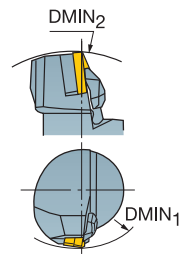

- VBMT, VBGT
VCGX,
VCGT, VCET
- VBMT, VCMW

							Dimensions, mm, inch								
		CZC _{MS}	DMIN ₂	RMPX	CNCS	Ordering code	DCON _{MS}	LF	WF	BAR			MIID		
										PSI	NM	KG			
		16	3/8	C4	145.0	70°	3	C4-SWBN-00055-16C1	40	55.0	0.6	150	3.0	0.31	VBMT 16 04 08
									1.575	2.165	.024	2175			
		C5	165.0	70°	3	C5-SWBN-00060-16C1	50	60.0	0.6	150	3.0	0.55	VBMT 16 04 08		
							1.969	2.362	.024	2175					
C6	190.0	70°	3	C6-SWBN-00065-16C1	63	65.0	0.6	150	3.0	0.97	VBMT 16 04 08				
					2.480	2.559	.024	2175							

R = Right hand, L = Left hand

CoroTurn® 107 QS shank tool for turning

Screw clamp design

KAPR
PSIR

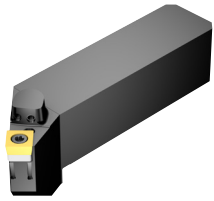

45.0°
45.0°

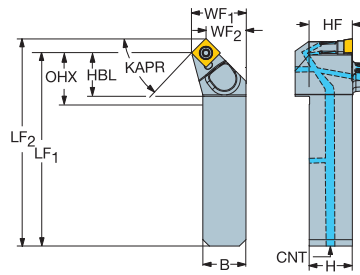

 SCMT



Metric version

		CZC _{MS}	OHX	CNSC	Ordering code	Dimensions, mm											MIID
						B	H	HBL	LF	WF	HF	CNT	BAR	NM	KG		
	09	20 x 20	52.5	3	QS-SSDCR202009C1	20.0	20.0	27.5	90.1	25.0	20.0	G 1/8-28	150	3.0	0.26	SCMT 09 T3 08	
		25 x 25	53.5	3	QS-SSDCR252509C1	25.0	25.0	28.5	106.1	32.0	25.0	G 1/8-28	150	3.0	0.47	SCMT 09 T3 08	

T-Max® P cutting unit for turning

Rigid clamp design



KAPR
PSIR

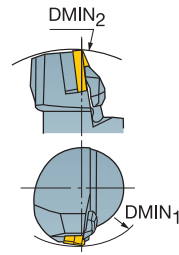

95.0°
-5.0°

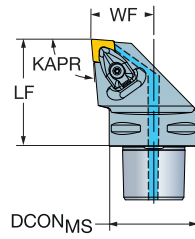

- CNMM
- CNMG
- CNMA, CNGA

							Dimensions, mm, inch								
		CZC _{MS}	DMIN ₁	DMIN ₂	CNCS	Ordering code	DCON _{MS}	LF	WF				MIID		
		12	1/2	C4	110.0	140.0	3	C4-DCLNR/L-27050-12B1	40	50.0	27.0	150	3.9	0.41	CNMG 12 04 08
									1.575	1.969	1.063	2175			
		C5	110.0	165.0	3	C5-DCLNR/L-35060-12B1	50	60.0	35.0	150	3.9	0.73	CNMG 12 04 08		
							1.969	2.362	1.378	2175					
		16	5/8	C6	125.0	190.0	3	C6-DCLNR/L-45065-16B1	63	65.0	45.0	150	6.4	1.27	CNMG 16 06 12
									2.480	2.559	1.772	2175			
19	3/4	C8	100.0	250.0	3	C8-DCLNR/L-55080-19B1	80	80.0	55.0	150	6.4	2.59	CNMG 19 06 12		
							3.150	3.150	2.165	2175					

R = Right hand, L = Left hand





T-Max® P cutting unit for turning

Rigid clamp design

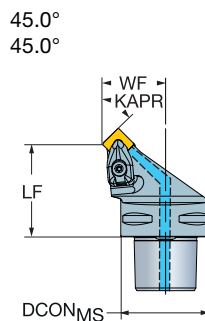
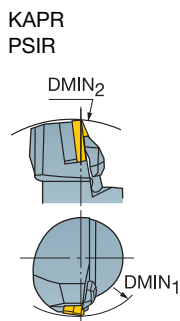

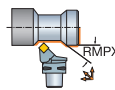
-  SNMM
-  SNMG
-  SNMA, SNGA



							Dimensions, mm, inch							
		CZC _{MS}	DMIN ₁	DMIN ₂	CNSC	Ordering code	DCON _{MS}	LPR	LF	WF				MIID
		C5	110.0	165.0	3	C5-DSSNR/L-35052-12B1	50	60.3	52.0	35.0	150	3.9	0.67	SNMG 12 04 08
		C6	120.0	190.0	3	C6-DSSNR/L-45054-15B1	63	64.2	54.0	45.0	150	6.4	1.13	SNMG 15 06 12
			4.724	7.480			2.480	2.529	2.126	1.772	2175			

R = Right hand, L = Left hand

T-Max® P cutting unit for turning

Rigid clamp design



KAPR
PSIR

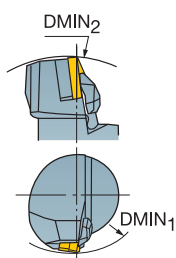

93.0°
-3.0°

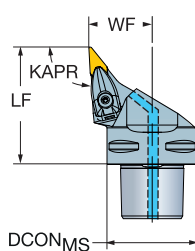

VNMG

								Dimensions, mm, inch						
	CZC _{MS}	DMIN ₁	DMIN ₂	RMPX	CNSC	Ordering code	DCON _{MS}	LF	WF				MIID	
														16
			4.331	6.102			1.575	2.441	1.063	2175				
			4.331	6.693	50°	3	C5-DVJNR/L-35065-16C1	50	65.0	35.0	150	3.0	0.67	VNMG 16 04 08
			4.331	6.693			1.969	2.559	1.378	2175				
			4.331	7.480	50°	3	C6-DVJNR/L-45065-16C1	63	65.0	45.0	150	3.0	1.03	VNMG 16 04 08
			4.331	7.480			2.480	2.559	1.772	2175				
			4.331	9.843	50°	3	C8-DVJNR/L-55080-16C1	80	80.0	55.0	150	3.0	2.23	VNMG 16 04 08
			4.331	9.843			3.150	3.150	2.165	2175				

R = Right hand, L = Left hand

ENG

T-Max® P cutting unit for turning

Lever clamp design

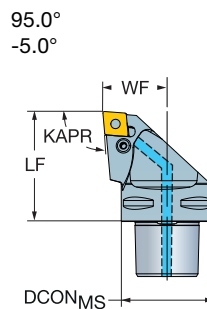
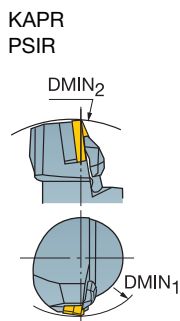
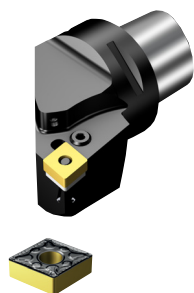

- CNMM
- CNMG
- CNMA, CNGA

							Dimensions, mm, inch							
		CZC _{MS}	DMIN ₁	DMIN ₂	CNSC	Ordering code	DCON _{MS}	LF	WF				MIID	
	12	1/2	C3	65.0	125.0	3	C3-PCLNR/L-22045-12C1	32	45.0	22.0	150	5.0	0.24	CNMG 12 04 08
				2.559	4.921			1.260	1.772	.866	2175			
			C4	65.0	140.0	3	C4-PCLNR/L-27050-12C1	40	50.0	27.0	150	5.0	0.42	CNMG 12 04 08
				2.559	5.512			1.575	1.969	1.063	2175			
			C5	90.0	165.0	3	C5-PCLNR/L-35060-12C1	50	60.0	35.0	150	5.0	0.76	CNMG 12 04 08
				3.543	6.496			1.969	2.362	1.378	2175			
	C6	85.0	195.0	3	C6-PCLNR/L-45065-12C1	63	65.0	45.0	150	5.0	1.31	CNMG 12 04 08		
		3.346	7.677			2.480	2.559	1.772	2175					
	C8	110.0	250.0	3	C8-PCLNR/L-55080-12C1	80	80.0	55.0	150	5.0	2.71	CNMG 12 04 08		
		4.331	9.843			3.150	3.150	2.165	2175					
	16	5/8	C6	105.0	195.0	3	C6-PCLNR/L-45065-16C1	63	65.0	45.0	150	5.0	1.34	CNMG 16 06 12
				4.134	7.677			2.480	2.559	1.772	2175			
C8			110.0	250.0	3	C8-PCLNR/L-55080-16C1	80	80.0	55.0	150	5.0	2.75	CNMG 16 06 12	
			4.331	9.843			3.150	3.150	2.165	2175				

R = Right hand, L = Left hand

T-Max® P cutting unit for turning

Lever clamp design

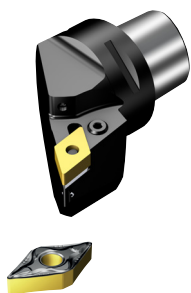

KAPR
PSIR

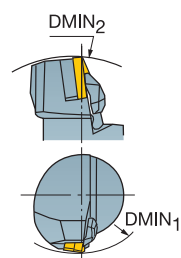

93.0°
-3.0°

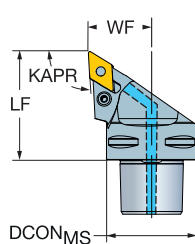

- DNMM, DNMX
- DNMG
- DNMA, DNGA

								Dimensions, mm, inch								
		CZC _{MS}	DMIN ₁	DMIN ₂	RMPX	CNSC	Ordering code	DCON _{MS}	LF	WF				MIID		
	11	3/8	C4	75.0	140.0	27°	3	C4-PDJNR/L-27050-11C1	40	50.0	27.0	150	2.0	0.39	DNMG 11 04 08	
				2.953	5.512					1.575	1.969	1.063	2175			
		C5	85.0	165.0	27°	3	C5-PDJNR/L-35060-11C1	50	60.0	35.0	150	2.0	0.73	DNMG 11 04 08		
			3.346	6.496					1.969	2.362	1.378	2175				
		15	1/2	C4	85.0	145.0	27°	3	C4-PDJNR/L-27055-15C1	40	55.0	27.0	150	5.0	0.42	DNMG 15 06 08
					3.346	5.709					1.575	2.165	1.063	2175		
	C5		80.0	165.0	27°	3	C5-PDJNR/L-35060-1504C1	50	60.0	35.0	150	5.0	0.71	DNMG 15 04 08		
			3.150	6.496					1.969	2.362	1.378	2175				
	C5		80.0	165.0	27°	3	C5-PDJNR/L-35060-15C1	50	60.0	35.0	150	5.0	0.71	DNMG 15 06 08		
			3.150	6.496					1.969	2.362	1.378	2175				
	C6	90.0	190.0	27°	3	C6-PDJNR/L-45065-1504C1	63	65.0	45.0	150	5.0	1.18	DNMG 15 04 08			
		3.543	7.480					2.480	2.559	1.772	2175					
C6	90.0	190.0	27°	3	C6-PDJNR/L-45065-15C1	63	65.0	45.0	150	5.0	1.18	DNMG 15 06 08				
	3.543	7.480					2.480	2.559	1.772	2175						
C8	120.0	250.0	27°	3	C8-PDJNR/L-55080-15C1	80	65.0	45.0	150	5.0	2.42	DNMG 15 06 08				
	4.724	9.843					3.150	2.559	1.772	2175						

R = Right hand, L = Left hand

T-Max® P QS shank tool for turning



Lever clamp design

KAPR
PSIR

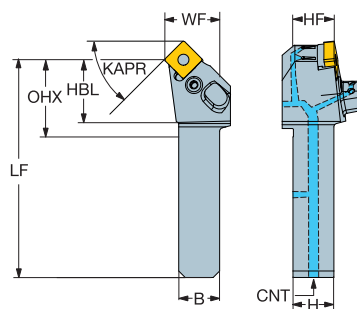
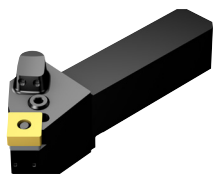

45.0°
45.0°



Metric version

		CZC _{MS}	OHX	CNSC	Ordering code	Dimensions, mm										MIID
						B	H	HBL	LF	WF	HF	CNT	BAR	NM	KG	
	12	20 x 20	52.7	3	QS-PSSNR/L2020-12C1	20.0	20.0	32.7	101.7	25.0	20.0	G 1/8-28	150	5.0	0.33	SNMG 12 04 08
		25 x 25	56.7	3	QS-PSSNR/L2525-12C1	25.0	25.0	31.7	115.7	32.0	25.0	G 1/8-28	150	5.0	0.55	SNMG 12 04 08

Inch version

		CZC _{MS}	OHX	CNSC	Ordering code	Dimensions, inch										MIID
						B	H	HBL	LF	WF	HF	CNT	PSI	FT/LBS	LBS	
	1/2	3/4 x 3/4	2.018	3	QS-PSSNR/L124C1	.750	.750	1.268	3.984	1.000	.750	G 1/8-28	2175	3.7	0.820	SNMG 432
		1 x 1	2.268	3	QS-PSSNR/L164C1	1.000	1.000	1.268	4.575	1.250	1.000	G 1/8-28	2175	3.7	1.323	SNMG 432

Parting and Grooving

CoroCut® 2

Blade for parting	49
QS shank tool for parting and grooving	50
Shank tool for parting and grooving	51
Shank tool for shallow grooving	56
Shank tool for face grooving	58
Shank tools for profiling	64
Cutting head for parting and grooving	66
Cutting head for face grooving	69
Boring bar for grooving	77

CoroCut® QD

Inserts	79
Blade for Y-axis parting	80
Shank for Y-axis parting	82

CoroCut® XS

Inserts	83
---------	----

CoroCut® 2 blade for parting

Screw clamp design

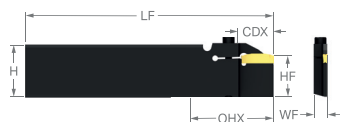
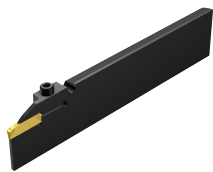

	SSC	CZC _{MS}	CDX ₁	OHX	OHN	Ordering code	Dimensions, mm					MIID
							H	LF	WF	NM	KG	
	H	25	25.0	55.0	27.0	C2R-BL25-RH25DF1	31.9	150.0	8.3	5.0	0.24	C2I-H2N-0400-
	J	25	25.0	55.0	27.0	C2R-BL25-RJ25DF1	31.9	150.0	8.3	5.0	0.25	C2I-J2N-0500-
	K	25	25.0	55.0	27.0	C2R-BL25-RK25DF1	31.9	150.0	8.3	5.0	0.25	C2I-K2N-0600-
	H	25	25.0	55.0	27.0	C2R-BR25-LH25DF1	31.9	150.0	8.3	5.0	0.24	C2I-H2N-0400-
	J	25	25.0	55.0	27.0	C2R-BR25-LJ25DF1	31.9	150.0	8.3	5.0	0.25	C2I-J2N-0500-
	K	25	25.0	55.0	27.0	C2R-BR25-LK25DF1	31.9	150.0	8.3	5.0	0.25	C2I-K2N-0600-

CoroCut® 2 QS shank tool for parting and grooving

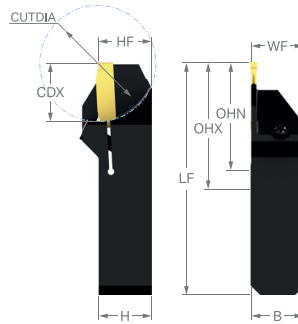
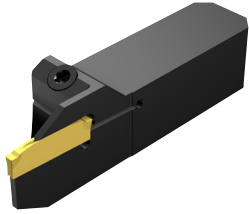

Metric version

SSC	CZC _{MS}	CDX ₁	OHX	OHN	Ordering code	Dimensions, mm					NM	KG	MIID	
						B	H	LF	WF	CUTDIA				
	D	10 x 10	10.0	30.0	23.2	C2R-QS10-R/LD10DS	10.0	10.0	70.0	10.0	20	2.5	0.05	C2I-D2N-0150-
		12 x 12	11.0	30.0	24.2	C2R-QS12-R/LD11DS	12.0	12.0	70.0	12.0	22	2.5	0.07	C2I-D2N-0150-
		16 x 16	8.0	30.0	21.2	C2R-QS16-R/LD08DS	16.0	16.0	70.0	16.0	16	2.5	0.12	C2I-D2N-0150-
		16 x 16	17.0	30.2	30.2	C2R-QS16-R/LD17DS	16.0	16.0	70.0	16.0	34	2.5	0.11	C2I-D2N-0150-

Inch version

SSC	CZC _{MS}	CDX ₁	OHX	OHN	Ordering code	Dimensions, inch							FT/LBS	LBS	MIID
						B	H	LF	WF	HF	CUTDIA				
	D	3/8 x 3/8	.375	1.181	.895	C2R-QSA06-R/LD10DS	.375	.375	2.756	.375	.377	.787	1.8	.097	C2I-D2N-0150-
		1/2 x 1/2	.430	1.181	.950	C2R-QSA08-R/LD11DS	.500	.500	2.756	.500	.502	.860	1.8	.170	C2I-D2N-0150-
		5/8 x 5/8	.320	1.181	.840	C2R-QSA10-R/LD08DS	.625	.625	2.756	.625	.627	.640	1.8	.269	C2I-D2N-0150-
		5/8 x 5/8	.670	1.190	1.190	C2R-QSA10-R/LD17DS	.625	.625	2.756	.625	.627	1.340	1.8	.236	C2I-D2N-0150-

CoroCut® 2 shank tool for parting and grooving

Screw clamp design

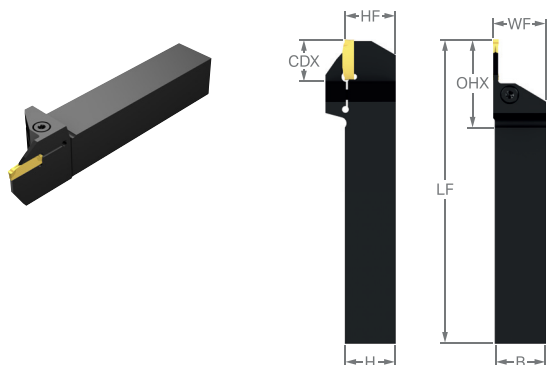

Metric version

SSC	CZC _{MS}	CDX ₁	OHX	OHN	Ordering code	Dimensions, mm						MIID
						B	H	LF	WF	NM	KG	
D	12 x 12	8.0	38.8	26.8	C2R-RS12-R/LD08DB	12.0	12.0	125.0	13.0	3.5	0.14	C2I-D2N-0150-
	16 x 16	8.0	42.8	26.8	C2R-RS16-R/LD08DB	16.0	16.0	125.0	17.0	3.5	0.23	C2I-D2N-0150-
	16 x 16	15.0	49.8	33.8	C2R-RS16-R/LD15DB	16.0	16.0	125.0	17.0	4.0	0.22	C2I-D2N-0150-
	20 x 20	8.0	46.8	26.8	C2R-RS20-R/LD08DB	20.0	20.0	125.0	21.0	3.5	0.36	C2I-D2N-0150-
	20 x 20	15.0	53.8	33.8	C2R-RS20-R/LD15DB	20.0	20.0	125.0	21.0	4.0	0.34	C2I-D2N-0150-
	25 x 25	8.0	51.8	26.8	C2R-RS25-R/LD08DB	25.0	25.0	150.0	26.0	3.5	0.68	C2I-D2N-0150-
H	16 x 16	13.0	51.7	35.7	C2R-RS16-R/LH13DB	16.0	16.0	125.0	17.0	4.5	0.23	C2I-H2N-0400-
	16 x 16	25.0	63.7	47.7	C2R-RS16-R/LH25DB	16.0	16.0	125.0	17.0	5.5	0.23	C2I-H2N-0400-
	20 x 20	13.0	55.7	35.7	C2R-RS20-R/LH13DB	20.0	20.0	125.0	21.0	4.5	0.35	C2I-H2N-0400-
	20 x 20	25.0	67.7	47.7	C2R-RS20-R/LH25DB	20.0	20.0	125.0	21.0	5.5	0.34	C2I-H2N-0400-
	25 x 25	13.0	60.7	35.7	C2R-RS25-R/LH13DB	25.0	25.0	150.0	26.0	4.5	0.66	C2I-H2N-0400-
	25 x 25	25.0	72.7	47.7	C2R-RS25-R/LH25DB	25.0	25.0	150.0	26.0	5.5	0.62	C2I-H2N-0400-
J	32 x 32	13.0	67.7	35.7	C2R-RS32-R/LH13DB	32.0	32.0	170.0	33.0	4.5	1.23	C2I-H2N-0400-
	32 x 32	25.0	79.7	47.7	C2R-RS32-R/LH25DB	32.0	32.0	170.0	33.0	5.5	1.15	C2I-H2N-0400-
	20 x 20	13.0	55.7	35.7	C2R-RS20-R/LJ13DB	20.0	20.0	125.0	21.0	4.5	0.36	C2I-J2N-0500-
	25 x 25	13.0	60.7	35.7	C2R-RS25-R/LJ13DB	25.0	25.0	150.0	26.0	4.5	0.67	C2I-J2N-0500-
	25 x 25	22.0	69.7	44.7	C2R-RS25-R/LJ22DB	25.0	25.0	150.0	26.0	4.5	0.64	C2I-J2N-0500-
	25 x 25	32.0	79.7	54.7	C2R-RS25-R/LJ32DB	25.0	25.0	150.0	26.0	5.5	0.62	C2I-J2N-0500-
K	32 x 32	13.0	67.7	35.7	C2R-RS32-R/LJ13DB	32.0	32.0	170.0	33.0	4.5	1.23	C2I-J2N-0500-
	32 x 32	32.0	86.7	54.7	C2R-RS32-R/LJ32DB	32.0	32.0	170.0	33.0	5.5	1.11	C2I-J2N-0500-
	25 x 25	16.0	63.7	38.7	C2R-RS25-R/LK16DB	25.0	25.0	150.0	26.0	4.5	0.66	C2I-K2N-0600-
	25 x 25	32.0	79.7	54.7	C2R-RS25-R/LK32DB	25.0	25.0	150.0	26.0	5.5	0.63	C2I-K2N-0600-
L	32 x 32	16.0	70.7	38.7	C2R-RS32-R/LK16DB	32.0	32.0	170.0	33.0	4.5	1.22	C2I-K2N-0600-
	32 x 32	32.0	86.7	54.7	C2R-RS32-R/LK32DB	32.0	32.0	170.0	33.0	5.5	1.12	C2I-K2N-0600-
	25 x 25	16.0	63.3	38.3	C2R-RS25-R/LL16DB	25.0	25.0	150.0	26.5	6.5	0.66	C2I-L2N-0800-
	25 x 25	25.0	72.3	47.3	C2R-RS25-R/LL25DB	25.0	25.0	150.0	26.5	6.5	0.63	C2I-L2N-0800-
	32 x 32	32.0	86.3	54.3	C2R-RS32-R/LL32DB	32.0	32.0	170.0	33.5	6.5	1.21	C2I-L2N-0800-

CoroCut® 2 shank tool for parting and grooving

Screw clamp design

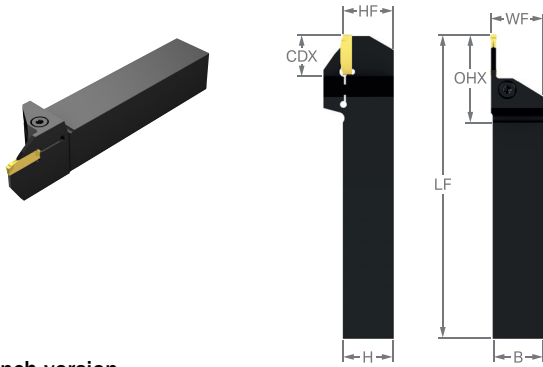

Inch version

SSC	CZC _{MS}	CDX ₁	OHX	OHN	Ordering code	Dimensions, inch						MIID	
						B	H	LF	WF	HF	FT/ LBS		LBS
L	1 x 1	1.000	2.879	1.879	C2R-RSA16-R/LL25DB	1.000	1.000	6.000	1.033	1.000	4.8	1.448	C2I-L2N-0800-
D	1/2 x 1/2	.320	1.560	1.060	C2R-RSA08-R/LD08DB	.500	.500	4.500	.512	.500	2.6	.300	C2I-D2N-0150-
	5/8 x 5/8	.320	1.685	1.060	C2R-RSA10-RD08DB	.625	.625	5.000	.670	.625	2.6	.516	C2I-D2N-0150-
	5/8 x 5/8	.590	1.955	1.330	C2R-RSA10-RD15DB	.625	.625	5.000	.670	.625	3.0	.498	C2I-D2N-0150-
	3/4 x 3/4	.320	1.810	1.060	C2R-RSA12-R/LD08DB	.750	.750	5.000	.825	.750	2.6	.739	C2I-D2N-0150-
	3/4 x 3/4	.590	2.080	1.330	C2R-RSA12-R/LD15DB	.750	.750	5.000	.827	.750	3.0	.699	C2I-D2N-0150-
	1 x 1	.320	2.060	1.060	C2R-RSA16-R/LD08DB	1.000	1.000	5.000	1.028	1.000	2.6	1.292	C2I-D2N-0150-
1 x 1	.590	2.330	1.330	C2R-RSA16-R/LD15DB	1.000	1.000	6.000	1.028	1.000	3.0	1.499	C2I-D2N-0150-	
H	5/8 x 5/8	.512	2.031	1.406	C2R-RSA10-R/LH13DB	.625	.625	5.000	.669	.625	3.3	.503	C2I-H2N-0400-
	3/4 x 3/4	.512	2.156	1.406	C2R-RSA12-R/LH13DB	.750	.750	5.000	.827	.750	3.3	.730	C2I-H2N-0400-
	3/4 x 3/4	.980	2.624	1.874	C2R-RSA12-R/LH25DB	.750	.750	5.000	.827	.750	4.1	.692	C2I-H2N-0400-
	1 x 1	.512	2.406	1.406	C2R-RSA16-R/LH13DB	1.000	1.000	5.000	1.024	1.000	3.3	1.250	C2I-H2N-0400-
	1 x 1	.980	2.874	1.874	C2R-RSA16-R/LH25DB	1.000	1.000	6.000	1.024	1.000	4.1	1.431	C2I-H2N-0400-
	1 1/4 x 1	.512	2.656	1.406	C2R-RSA20-R/LH13DB	1.250	1.250	6.000	1.299	1.250	3.3	2.372	C2I-H2N-0400-
1 1/4 x 1	.980	3.124	1.874	C2R-RSA20-R/LH25DB	1.250	1.250	6.000	1.299	1.250	4.1	2.205	C2I-H2N-0400-	
J	1 x 1	.512	2.406	1.406	C2R-RSA16-R/LJ13DB	1.000	1.000	5.000	1.024	1.000	3.3	1.257	C2I-J2N-0500-
	1 x 1	1.260	3.154	2.154	C2R-RSA16-R/LJ32DB	1.000	1.000	6.000	1.024	1.000	4.1	1.422	C2I-J2N-0500-
	1 1/4 x 1	.512	2.656	1.406	C2R-RSA20-R/LJ13DB	1.250	1.250	6.000	1.299	1.250	3.3	2.379	C2I-J2N-0500-
	1 1/4 x 1	1.260	3.404	2.154	C2R-RSA20-R/LJ32DB	1.250	1.250	6.000	1.299	1.250	4.1	2.127	C2I-J2N-0500-
	1 1/2 x 1	1.260	3.654	2.154	C2R-RSA24-R/LJ32DB	1.500	1.500	8.000	1.614	1.500	4.1	4.288	C2I-J2N-0500-
K	1 x 1	.630	2.524	1.524	C2R-RSA16-R/LK16DB	1.000	1.000	5.000	1.024	1.000	3.3	1.246	C2I-K2N-0600-
	1 x 1	1.260	3.154	2.154	C2R-RSA16-R/LK32DB	1.000	1.000	6.000	1.024	1.000	4.1	1.444	C2I-K2N-0600-
	1 1/4 x 1	.630	2.774	1.524	C2R-RSA20-R/LK16DB	1.250	1.250	6.000	1.299	1.250	3.3	2.355	C2I-K2N-0600-
	1 1/4 x 1	1.260	3.404	2.154	C2R-RSA20-R/LK32DB	1.250	1.250	6.000	1.299	1.250	4.1	2.150	C2I-K2N-0600-
L	1 x 1	.630	2.509	1.509	C2R-RSA16-R/LL16DB	1.000	1.000	6.000	1.033	1.000	4.8	1.517	C2I-L2N-0800-
	1 1/4 x 1	1.000	3.129	1.879	C2R-RSA20-R/LL25DB	1.250	1.250	6.000	1.300	1.250	4.8	2.222	C2I-L2N-0800-
	1 1/4 x 1	1.380	3.509	2.259	C2R-RSA20-R/LL35DB	1.250	1.250	7.000	1.300	1.250	4.8	2.573	C2I-L2N-0800-
	1 1/2 x 1	1.380	3.759	2.259	C2R-RSA24-R/LL35DB	1.500	1.500	8.000	1.614	1.500	4.8	4.262	C2I-L2N-0800-

CoroCut® 2 shank tool for parting and grooving

Screw clamp design

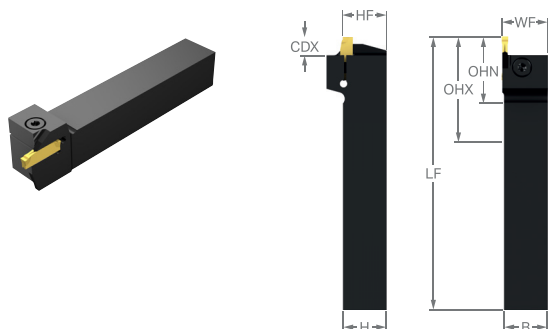

Metric version

		Dimensions, mm												
		SSC	CZC _{MS}	CDX ₁	OHX	OHN	Ordering code	B	H	LF	WF	NM	KG	MIID
	K	20 x 20	8.0	50.7	30.7	C2R-RS20-R/LK08DC	20.0	20.0	125.0	21.0	4.5	0.37	C2I-K2N-0600-	
		25 x 25	8.0	55.7	30.7	C2R-RS25-R/LK08DC	25.0	25.0	150.0	26.0	4.5	0.69	C2I-K2N-0600-	

Inch version

		Dimensions, inch													
		SSC	CZC _{MS}	CDX ₁	OHX	OHN	Ordering code	B	H	LF	WF	HF	FT/LBS	LBS	MIID
	K	3/4 x 3/4	.320	1.964	1.214	C2R-RSA12-R/LK08DC	.750	.750	5.000	.787	.750	3.3	.741	C2I-K2N-0600-	
		1 x 1	.320	2.214	1.214	C2R-RSA16-R/LK08DC	1.000	1.000	6.000	1.024	1.000	3.3	1.596	C2I-K2N-0600-	

CoroCut® 2 shank tool for parting and grooving

Screw clamp design

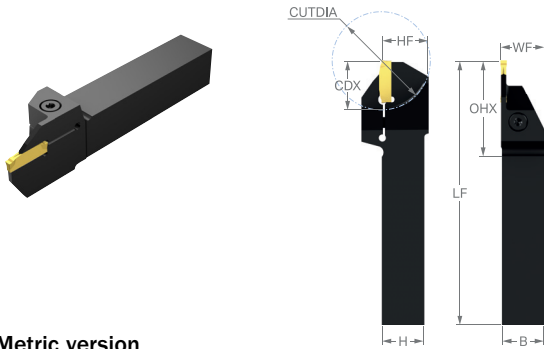

Metric version

		Dimensions, mm													
		SSC	CZC _{MS}	CDX ₁	OHX	OHN	Ordering code	B	H	LF	WF	CUTDIA	NM	KG	MIID
	H	20 x 20	22.0	64.7	44.7	C2R-RS20-R/LH22DD	20.0	20.0	125.0	21.0	52	4.5	0.35	C2I-H2N-0400-	
		25 x 25	22.0	69.7	44.7	C2R-RS25-R/LH22DD	25.0	25.0	150.0	26.0	52	4.5	0.65	C2I-H2N-0400-	

Inch version

		Dimensions, inch														
		SSC	CZC _{MS}	CDX ₁	OHX	OHN	Ordering code	B	H	LF	WF	HF	CUTDIA	FT/ LBS	LBS	MIID
	H	3/4 x 3/4	.870	2.514	1.764	C2R-RSA12-R/LH22DD	.750	.750	5.000	.774	.750	2.067	3.3	.714	C2I-H2N-0400-	
		1 x 1	.870	2.764	1.764	C2R-RSA16-R/LH22DD	1.000	1.000	5.000	1.024	1.000	2.067	3.3	1.213	C2I-H2N-0400-	

CoroCut® 2 shank tool for parting and grooving

Screw clamp design

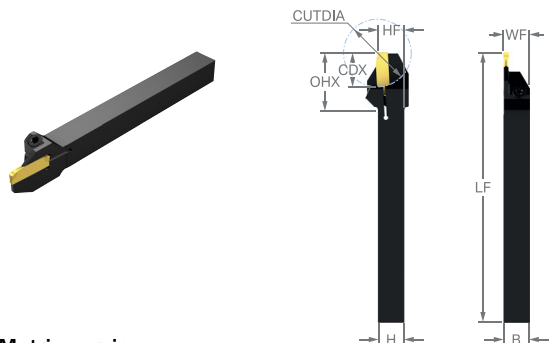

Metric version

		Dimensions, mm													
		SSC	CZC _{MS}	CDX ₁	OHX	OHN	Ordering code	B	H	LF	WF	CUTDIA	NM	KG	MIID
	D	10 x 10	10.0	33.2	23.2	C2R-RS10-R/LD10DS	10.0	10.0	125.0	10.0	20	2.5	0.09	C2I-D2N-0150-	
		12 x 12	11.0	36.2	24.2	C2R-RS12-R/LD11DS	12.0	12.0	125.0	12.0	22	2.5	0.13	C2I-D2N-0150-	
		16 x 16	8.0	37.2	21.2	C2R-RS16-R/LD08DS	16.0	16.0	125.0	16.0	16	2.5	0.23	C2I-D2N-0150-	
		16 x 16	17.0	46.2	30.2	C2R-RS16-R/LD17DS	16.0	16.0	125.0	16.0	34	2.5	0.16	C2I-D2N-0150-	

Inch version

		Dimensions, inch														
		SSC	CZC _{MS}	CDX ₁	OHX	OHN	Ordering code	B	H	LF	WF	HF	CUTDIA	F _T /LBS	LBS	MIID
	D	3/8 x 3/8	.390	1.285	.910	C2R-RSA06-R/LD10DS	.375	.375	4.921	.375	.377	.780	1.8	.181	C2I-D2N-0150-	
		1/2 x 1/2	.430	1.450	.950	C2R-RSA08-R/LD11DS	.500	.500	4.921	.500	.502	.860	1.8	.322	C2I-D2N-0150-	
		5/8 x 5/8	.320	1.465	.840	C2R-RSA10-R/LD08DS	.625	.625	4.921	.625	.627	.640	1.8	.507	C2I-D2N-0150-	
		5/8 x 5/8	.670	1.815	1.190	C2R-RSA10-R/LD17DS	.625	.625	4.921	.625	.627	1.340	1.8	.474	C2I-D2N-0150-	

CoroCut® 2 shank tool for shallow grooving

Screw clamp design

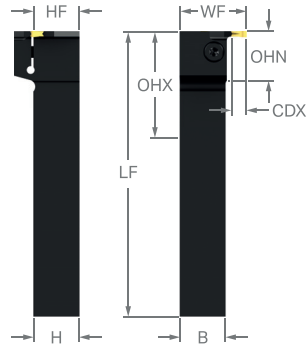
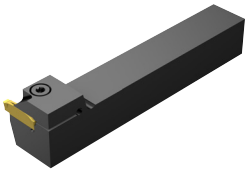

Metric version

								Dimensions, mm						
SSC	CZC _{MS}	CDX ₁	CDX ₂	OHX	OHN	Ordering code	B	H	LF	WF	BAR	NM	KG	MIID
K	20 x 20	8.0	4.5	49.6	29.6	C2A-RS20-LGK08B-DC	20.0	20.0	125.0	30.0	150	4.5	0.41	C2I-K2N-0600-
	25 x 25	8.0	4.5	54.6	29.6	C2A-RS25-LGK08B-DC	25.0	25.0	150.0	35.0	150	4.5	0.76	C2I-K2N-0600-

Inch version

								Dimensions, inch								
SSC	CZC _{MS}	CDX ₁	CDX ₂	OHX	OHN	Ordering code	B	H	LF	WF	HF	PSI	FT/LBS	LBS	MIID	
K	3/4 x 3/4	.315	.177	1.915	1.165	C2A-RSA12-LGK08B-DC	.750	.750	5.000	1.144	.750	2175	3.3	.833	C2I-K2N-0600-	
	1 x 1	.315	.177	2.165	1.165	C2A-RSA16-LGK08B-DC	1.000	1.000	6.000	1.394	1.000	2175	3.3	1.753	C2I-K2N-0600-	

CoroCut® 2 shank tool for shallow grooving

Screw clamp design

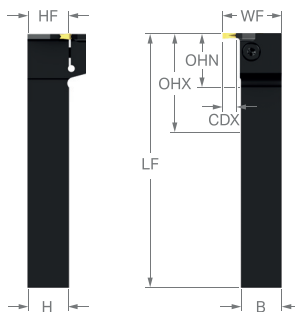
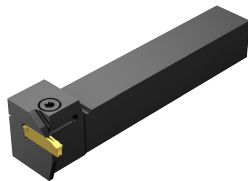

Metric version

							Dimensions, mm							
SSC	CZC _{MS}	CDX ₁	CDX ₂	OHX	OHN	Ordering code	B	H	LF	WF	BAR	NM	KG	MIID
K	25 x 25	8.0	4.5	54.6	29.6	C2A-RS25-RGK08B-DC	25.0	25.0	150.0	35.0	150	4.5	0.76	C2I-K2N-0600-
K	20 x 20	8.0	4.5	49.6	29.6	C2A-RS20-RGK08B-DC	20.0	20.0	125.0	30.0	150	4.5	0.41	C2I-K2N-0600-

Inch version

							Dimensions, inch								
SSC	CZC _{MS}	CDX ₁	CDX ₂	OHX	OHN	Ordering code	B	H	LF	WF	HF	PSI	FT/LBS	LBS	MIID
K	3/4 x 3/4	.315	.177	1.915	1.165	C2A-RSA12-RGK08B-DC	.750	.750	5.000	1.144	.750	2175	3.3	.833	C2I-K2N-0600-
	1 x 1	.315	.177	2.165	1.165	C2A-RSA16-RGK08B-DC	1.000	1.000	6.000	1.394	1.000	2175	3.3	1.753	C2I-K2N-0600-

CoroCut® 2 shank tool for face grooving

Screw clamp design

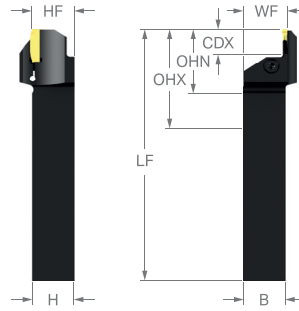
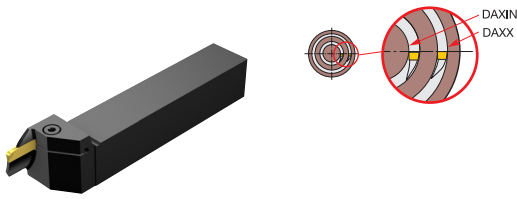

Metric version

SSC	CZC _{MS}	CDX	DAXIN	DAXX	OHX	OHN	Ordering code	Dimensions, mm						MID	
								B	H	LF	WF	BAR	NM		KG
H	20 x 20	18.0	40.0	60.0	60.7	40.7	C2A-RS20-LFH18B-040DB	20.0	20.0	125.0	21.0	150	4.5	0.35	C2I-H2N-0400-
	20 x 20	18.0	52.0	72.0	60.7	40.7	C2A-RS20-LFH18B-052DB	20.0	20.0	125.0	21.0	150	4.5	0.35	C2I-H2N-0400-
	20 x 20	18.0	64.0	100.0	60.7	40.7	C2A-RS20-LFH18B-064DB	20.0	20.0	125.0	21.0	150	4.5	0.35	C2I-H2N-0400-
	20 x 20	18.0	92.0	140.0	60.7	40.7	C2A-RS20-LFH18B-092DB	20.0	20.0	125.0	21.0	150	4.5	0.35	C2I-H2N-0400-
	20 x 20	18.0	132.0	230.0	60.7	40.7	C2A-RS20-LFH18B-132DB	20.0	20.0	125.0	21.0	150	4.5	0.34	C2I-H2N-0400-
	20 x 20	18.0	220.0	500.0	60.7	40.7	C2A-RS20-LFH18B-220DB	20.0	20.0	125.0	21.0	150	4.5	0.34	C2I-H2N-0400-
	25 x 25	18.0	40.0	60.0	65.7	40.7	C2A-RS25-LFH18B-040DB	25.0	25.0	150.0	26.0	150	4.5	0.66	C2I-H2N-0400-
	25 x 25	18.0	52.0	72.0	65.7	40.7	C2A-RS25-LFH18B-052DB	25.0	25.0	150.0	26.0	150	4.5	0.66	C2I-H2N-0400-
	25 x 25	18.0	64.0	100.0	65.7	40.7	C2A-RS25-LFH18B-064DB	25.0	25.0	150.0	26.0	150	4.5	0.65	C2I-H2N-0400-
	25 x 25	18.0	92.0	140.0	65.7	40.7	C2A-RS25-LFH18B-092DB	25.0	25.0	150.0	26.0	150	4.5	0.65	C2I-H2N-0400-
	25 x 25	18.0	132.0	230.0	65.7	40.7	C2A-RS25-LFH18B-132DB	25.0	25.0	150.0	26.0	150	4.5	0.65	C2I-H2N-0400-
	25 x 25	18.0	220.0	500.0	65.7	40.7	C2A-RS25-LFH18B-220DB	25.0	25.0	150.0	26.0	150	4.5	0.65	C2I-H2N-0400-
25 x 25	18.0	300.0	1100.0	65.7	40.7	C2A-RS25-LFH18B-300DB	25.0	25.0	150.0	26.0	150	4.5	0.64	C2I-H2N-0400-	
J	25 x 25	18.0	40.0	70.0	65.7	40.7	C2A-RS25-LFJ18B-040DB	25.0	25.0	150.0	26.0	150	4.5	0.66	C2I-J2N-0500-
	25 x 25	18.0	60.0	95.0	65.7	40.7	C2A-RS25-LFJ18B-060DB	25.0	25.0	150.0	26.0	150	4.5	0.66	C2I-J2N-0500-
	25 x 25	18.0	85.0	130.0	65.7	40.7	C2A-RS25-LFJ18B-085DB	25.0	25.0	150.0	26.0	150	4.5	0.65	C2I-J2N-0500-
	25 x 25	18.0	120.0	180.0	65.7	40.7	C2A-RS25-LFJ18B-120DB	25.0	25.0	150.0	26.0	150	4.5	0.65	C2I-J2N-0500-
	25 x 25	18.0	175.0	500.0	65.7	40.7	C2A-RS25-LFJ18B-175DB	25.0	25.0	150.0	26.0	150	4.5	0.65	C2I-J2N-0500-
K	25 x 25	18.0	40.0	70.0	65.7	40.7	C2A-RS25-LFK18B-040DB	25.0	25.0	150.0	26.0	150	4.5	0.67	C2I-K2N-0600-
	25 x 25	18.0	58.0	100.0	65.7	40.7	C2A-RS25-LFK18B-058DB	25.0	25.0	150.0	26.0	150	4.5	0.66	C2I-K2N-0600-
	25 x 25	18.0	88.0	180.0	65.7	40.7	C2A-RS25-LFK18B-088DB	25.0	25.0	150.0	26.0	150	4.5	0.66	C2I-K2N-0600-
	25 x 25	18.0	168.0	400.0	65.7	40.7	C2A-RS25-LFK18B-168DB	25.0	25.0	150.0	26.0	150	4.5	0.65	C2I-K2N-0600-
	25 x 25	18.0	220.0	1000.0	65.7	40.7	C2A-RS25-LFK18B-220DB	25.0	25.0	150.0	26.0	150	4.5	0.65	C2I-K2N-0600-
	32 x 32	18.0	220.0	1000.0	72.7	40.7	C2A-RS32-LFK18B-220DB	32.0	32.0	170.0	33.0	150	4.5	1.21	C2I-K2N-0600-
L	25 x 25	23.0	50.0	80.0	70.3	45.3	C2A-RS25-LFL23B-050DB	25.0	25.0	150.0	26.5	150	6.5	0.65	C2I-L2N-0800-
	25 x 25	23.0	75.0	150.0	70.3	45.3	C2A-RS25-LFL23B-075DB	25.0	25.0	150.0	26.5	150	6.5	0.64	C2I-L2N-0800-
	25 x 25	23.0	140.0	400.0	70.3	45.3	C2A-RS25-LFL23B-140DB	25.0	25.0	150.0	26.5	150	6.5	0.63	C2I-L2N-0800-
	32 x 32	23.0	75.0	150.0	77.3	45.3	C2A-RS32-LFL23B-075DB	32.0	32.0	170.0	33.5	150	6.5	1.18	C2I-L2N-0800-
	32 x 32	23.0	140.0	400.0	77.3	45.3	C2A-RS32-LFL23B-140DB	32.0	32.0	170.0	33.5	150	6.5	1.17	C2I-L2N-0800-

CoroCut® 2 shank tool for face grooving

Screw clamp design

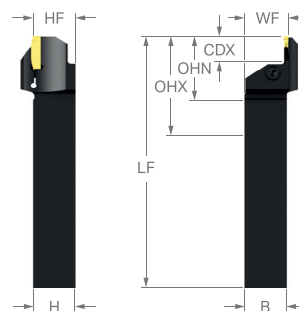
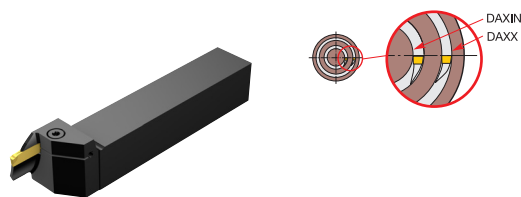

Inch version

SSC	CZC _{MS}	CDX	DAXIN	DAXX	OHX	OHN	Ordering code	Dimensions, inch							MID	
								B	H	LF	WF	HF	PSI	FT/LBS		LBS
H	1 x 1	.709	1.575	2.362	2.603	1.603	C2A-RSA16-LFH18B-040DB	1.000	1.000	6.000	1.039	1.000	2175	3.3	1.519	C2I-H2N-0400-
	1 x 1	.709	2.047	2.835	2.603	1.603	C2A-RSA16-LFH18B-052DB	1.000	1.000	6.000	1.039	1.000	2175	3.3	1.519	C2I-H2N-0400-
	1 x 1	.709	2.520	3.937	2.603	1.603	C2A-RSA16-LFH18B-064DB	1.000	1.000	6.000	1.039	1.000	2175	3.3	1.506	C2I-H2N-0400-
	1 x 1	.709	3.622	5.512	2.603	1.603	C2A-RSA16-LFH18B-092DB	1.000	1.000	6.000	1.039	1.000	2175	3.3	1.501	C2I-H2N-0400-
	1 x 1	.709	5.197	9.055	2.603	1.603	C2A-RSA16-LFH18B-132DB	1.000	1.000	6.000	1.039	1.000	2175	3.3	1.495	C2I-H2N-0400-
	1 x 1	.709	8.661	19.685	2.603	1.603	C2A-RSA16-LFH18B-220DB	1.000	1.000	6.000	1.039	1.000	2175	3.3	1.493	C2I-H2N-0400-
J	1 x 1	.709	11.811	31.496	2.603	1.603	C2A-RSA16-LFH18B-300DB	1.000	1.000	6.000	1.039	1.000	2175	3.3	1.490	C2I-H2N-0400-
	1 x 1	.709	1.575	2.756	2.603	1.603	C2A-RSA16-LFJ18B-040DB	1.000	1.000	6.000	1.039	1.000	2175	3.3	1.519	C2I-J2N-0500-
	1 x 1	.709	2.362	3.740	2.603	1.603	C2A-RSA16-LFJ18B-060DB	1.000	1.000	6.000	1.039	1.000	2175	3.3	1.517	C2I-J2N-0500-
	1 x 1	.709	3.346	5.118	2.603	1.603	C2A-RSA16-LFJ18B-085DB	1.000	1.000	6.000	1.039	1.000	2175	3.3	1.512	C2I-J2N-0500-
	1 x 1	.709	4.724	7.087	2.603	1.603	C2A-RSA16-LFJ18B-120DB	1.000	1.000	6.000	1.039	1.000	2175	3.3	1.508	C2I-J2N-0500-
	1 x 1	.709	6.890	19.685	2.603	1.603	C2A-RSA16-LFJ18B-175DB	1.000	1.000	6.000	1.039	1.000	2175	3.3	1.499	C2I-J2N-0500-
K	1 x 1	.709	1.575	2.756	2.603	1.603	C2A-RSA16-LFK18B-040DB	1.000	1.000	6.000	1.039	1.000	2175	3.3	1.537	C2I-K2N-0600-
	1 x 1	.709	2.283	3.400	2.603	1.603	C2A-RSA16-LFK18B-058DB	1.000	1.000	6.000	1.039	1.000	2175	3.3	1.534	C2I-K2N-0600-
	1 x 1	.709	3.465	7.087	2.603	1.603	C2A-RSA16-LFK18B-088DB	1.000	1.000	6.000	1.039	1.000	2175	3.3	1.515	C2I-K2N-0600-
	1 x 1	.709	6.614	15.748	2.603	1.603	C2A-RSA16-LFK18B-168DB	1.000	1.000	6.000	1.039	1.000	2175	3.3	1.510	C2I-K2N-0600-
	1 x 1	.709	8.661	39.370	2.603	1.603	C2A-RSA16-LFK18B-220DB	1.000	1.000	6.000	1.039	1.000	2175	3.3	1.508	C2I-K2N-0600-
L	1 x 1	.906	2.953	5.906	2.785	1.785	C2A-RSA16-LFL23B-075DB	1.000	1.000	6.000	1.063	1.000	2175	4.8	1.473	C2I-L2N-0800-
	1 x 1	.906	5.512	15.748	2.785	1.785	C2A-RSA16-LFL23B-140DB	1.000	1.000	6.000	1.063	1.000	2175	4.8	1.464	C2I-L2N-0800-
	1 1/4 x 1	.906	2.953	5.906	3.035	1.785	C2A-RSA20-LFL23B-075DB	1.250	1.250	6.000	1.309	1.250	2175	4.8	2.262	C2I-L2N-0800-
	1 1/4 x 1	.906	5.512	15.748	3.035	1.785	C2A-RSA20-LFL23B-140DB	1.250	1.250	6.000	1.309	1.250	2175	4.8	2.247	C2I-L2N-0800-

CoroCut® 2 shank tool for face grooving

Screw clamp design

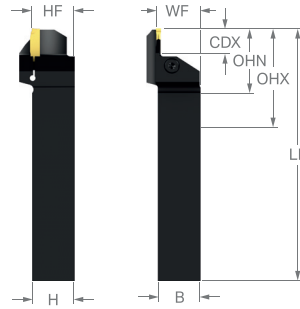
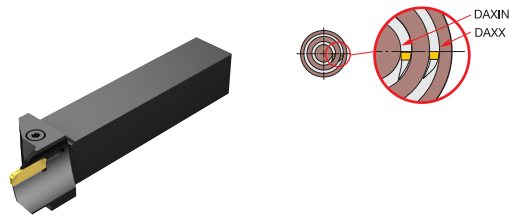

Metric version

SSC	CZC _{MS}	CDX	DAXIN	DAXX	OHX	OHN	Ordering code	Dimensions, mm						MID	
								B	H	LF	WF	BAR	NM		KG
H	20 x 20	18.0	40.0	60.0	60.7	40.7	C2A-RS20-RFH18B-040DB	20.0	20.0	125.0	21.0	150	4.5	0.35	C2I-H2N-0400-
	20 x 20	18.0	52.0	72.0	60.7	40.7	C2A-RS20-RFH18B-052DB	20.0	20.0	125.0	21.0	150	4.5	0.35	C2I-H2N-0400-
	20 x 20	18.0	64.0	100.0	60.7	40.7	C2A-RS20-RFH18B-064DB	20.0	20.0	125.0	21.0	150	4.5	0.35	C2I-H2N-0400-
	20 x 20	18.0	92.0	140.0	60.7	40.7	C2A-RS20-RFH18B-092DB	20.0	20.0	125.0	21.0	150	4.5	0.35	C2I-H2N-0400-
	20 x 20	18.0	132.0	230.0	60.7	40.7	C2A-RS20-RFH18B-132DB	20.0	20.0	125.0	21.0	150	4.5	0.34	C2I-H2N-0400-
	20 x 20	18.0	220.0	500.0	60.7	40.7	C2A-RS20-RFH18B-220DB	20.0	20.0	125.0	21.0	150	4.5	0.34	C2I-H2N-0400-
	25 x 25	18.0	40.0	60.0	65.7	40.7	C2A-RS25-RFH18B-040DB	25.0	25.0	150.0	26.0	150	4.5	0.66	C2I-H2N-0400-
	25 x 25	18.0	52.0	72.0	65.7	40.7	C2A-RS25-RFH18B-052DB	25.0	25.0	150.0	26.0	150	4.5	0.66	C2I-H2N-0400-
	25 x 25	18.0	64.0	100.0	65.7	40.7	C2A-RS25-RFH18B-064DB	25.0	25.0	150.0	26.0	150	4.5	0.65	C2I-H2N-0400-
	25 x 25	18.0	92.0	140.0	65.7	40.7	C2A-RS25-RFH18B-092DB	25.0	25.0	150.0	26.0	150	4.5	0.65	C2I-H2N-0400-
	25 x 25	18.0	132.0	230.0	65.7	40.7	C2A-RS25-RFH18B-132DB	25.0	25.0	150.0	26.0	150	4.5	0.65	C2I-H2N-0400-
	25 x 25	18.0	220.0	500.0	65.7	40.7	C2A-RS25-RFH18B-220DB	25.0	25.0	150.0	26.0	150	4.5	0.65	C2I-H2N-0400-
25 x 25	18.0	300.0	1100.0	65.7	40.7	C2A-RS25-RFH18B-300DB	25.0	25.0	150.0	26.0	150	4.5	0.64	C2I-H2N-0400-	
J	25 x 25	18.0	40.0	70.0	65.7	40.7	C2A-RS25-RFJ18B-040DB	25.0	25.0	150.0	26.0	150	4.5	0.66	C2I-J2N-0500-
	25 x 25	18.0	60.0	95.0	65.7	40.7	C2A-RS25-RFJ18B-060DB	25.0	25.0	150.0	26.0	150	4.5	0.66	C2I-J2N-0500-
	25 x 25	18.0	85.0	130.0	65.7	40.7	C2A-RS25-RFJ18B-085DB	25.0	25.0	150.0	26.0	150	4.5	0.65	C2I-J2N-0500-
	25 x 25	18.0	120.0	180.0	65.7	40.7	C2A-RS25-RFJ18B-120DB	25.0	25.0	150.0	26.0	150	4.5	0.65	C2I-J2N-0500-
	25 x 25	18.0	175.0	500.0	65.7	40.7	C2A-RS25-RFJ18B-175DB	25.0	25.0	150.0	26.0	150	4.5	0.65	C2I-J2N-0500-
K	25 x 25	18.0	40.0	70.0	65.7	40.7	C2A-RS25-RFK18B-040DB	25.0	25.0	150.0	26.0	150	4.5	0.67	C2I-K2N-0600-
	25 x 25	18.0	58.0	100.0	65.7	40.7	C2A-RS25-RFK18B-058DB	25.0	25.0	150.0	26.0	150	4.5	0.66	C2I-K2N-0600-
	25 x 25	18.0	88.0	180.0	65.7	40.7	C2A-RS25-RFK18B-088DB	25.0	25.0	150.0	26.0	150	4.5	0.66	C2I-K2N-0600-
	25 x 25	18.0	168.0	400.0	65.7	40.7	C2A-RS25-RFK18B-168DB	25.0	25.0	150.0	26.0	150	4.5	0.65	C2I-K2N-0600-
	25 x 25	18.0	220.0	1000.0	65.7	40.7	C2A-RS25-RFK18B-220DB	25.0	25.0	150.0	26.0	150	4.5	0.65	C2I-K2N-0600-
	32 x 32	18.0	88.0	180.0	72.7	40.7	C2A-RS32-RFK18B-088DB	32.0	32.0	170.0	33.0	150	4.5	1.21	C2I-K2N-0600-
	32 x 32	18.0	168.0	400.0	72.7	40.7	C2A-RS32-RFK18B-168DB	32.0	32.0	170.0	33.0	150	4.5	1.21	C2I-K2N-0600-
L	25 x 25	23.0	50.0	80.0	70.3	45.3	C2A-RS25-RFL23B-050DB	25.0	25.0	150.0	26.5	150	6.5	0.65	C2I-L2N-0800-
	25 x 25	23.0	75.0	150.0	70.3	45.3	C2A-RS25-RFL23B-075DB	25.0	25.0	150.0	26.5	150	6.5	0.64	C2I-L2N-0800-
	25 x 25	23.0	140.0	400.0	70.3	45.3	C2A-RS25-RFL23B-140DB	25.0	25.0	150.0	26.5	150	6.5	0.63	C2I-L2N-0800-
	32 x 32	23.0	75.0	150.0	77.3	45.3	C2A-RS32-RFL23B-075DB	32.0	32.0	170.0	33.5	150	6.5	1.18	C2I-L2N-0800-
	32 x 32	23.0	140.0	400.0	77.3	45.3	C2A-RS32-RFL23B-140DB	32.0	32.0	170.0	33.5	150	6.5	1.17	C2I-L2N-0800-

ENG

CoroCut® 2 shank tool for face grooving

Screw clamp design

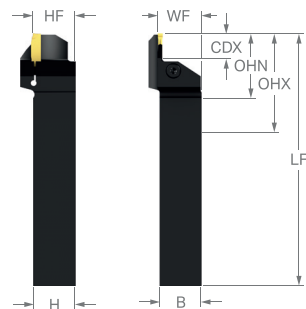
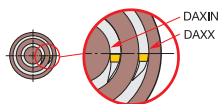
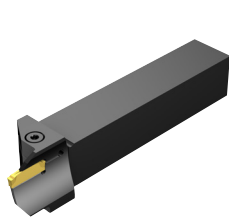

Inch version

SSC	CZC _{MS}	CDX	DAXIN	DAXX	OHX	OHN	Ordering code	Dimensions, inch							MID	
								B	H	Lf	WF	HF	PSI	FT/LBS		LBS
H	1 x 1	.709	1.575	2.362	2.603	1.603	C2A-RSA16-RFH18B-040DB	1.000	1.000	6.000	1.039	1.000	2175	3.3	1.519	C2I-H2N-0400-
	1 x 1	.709	2.047	2.835	2.603	1.603	C2A-RSA16-RFH18B-052DB	1.000	1.000	6.000	1.039	1.000	2175	3.3	1.519	C2I-H2N-0400-
	1 x 1	.709	2.520	3.937	2.603	1.603	C2A-RSA16-RFH18B-064DB	1.000	1.000	6.000	1.039	1.000	2175	3.3	1.506	C2I-H2N-0400-
	1 x 1	.709	3.622	5.512	2.603	1.603	C2A-RSA16-RFH18B-092DB	1.000	1.000	6.000	1.039	1.000	2175	3.3	1.501	C2I-H2N-0400-
	1 x 1	.709	5.197	9.055	2.603	1.603	C2A-RSA16-RFH18B-132DB	1.000	1.000	6.000	1.039	1.000	2175	3.3	1.495	C2I-H2N-0400-
	1 x 1	.709	8.661	19.685	2.603	1.603	C2A-RSA16-RFH18B-220DB	1.000	1.000	6.000	1.039	1.000	2175	3.3	1.493	C2I-H2N-0400-
J	1 x 1	.709	11.811	31.496	2.603	1.603	C2A-RSA16-RFH18B-300DB	1.000	1.000	6.000	1.039	1.000	2175	3.3	1.490	C2I-H2N-0400-
	1 x 1	.709	1.575	2.756	2.603	1.603	C2A-RSA16-RFJ18B-040DB	1.000	1.000	6.000	1.039	1.000	2175	3.3	1.519	C2I-J2N-0500-
	1 x 1	.709	2.362	3.740	2.603	1.603	C2A-RSA16-RFJ18B-060DB	1.000	1.000	6.000	1.039	1.000	2175	3.3	1.517	C2I-J2N-0500-
	1 x 1	.709	3.346	5.118	2.603	1.603	C2A-RSA16-RFJ18B-085DB	1.000	1.000	6.000	1.039	1.000	2175	3.3	1.512	C2I-J2N-0500-
	1 x 1	.709	4.724	7.087	2.603	1.603	C2A-RSA16-RFJ18B-120DB	1.000	1.000	6.000	1.039	1.000	2175	3.3	1.508	C2I-J2N-0500-
	1 x 1	.709	6.890	19.685	2.603	1.603	C2A-RSA16-RFJ18B-175DB	1.000	1.000	6.000	1.039	1.000	2175	3.3	1.499	C2I-J2N-0500-
K	1 x 1	.709	1.575	2.756	2.603	1.603	C2A-RSA16-RFK18B-040DB	1.000	1.000	6.000	1.039	1.000	2175	3.3	1.537	C2I-K2N-0600-
	1 x 1	.709	2.283	3.400	2.603	1.603	C2A-RSA16-RFK18B-058DB	1.000	1.000	6.000	1.039	1.000	2175	3.3	1.534	C2I-K2N-0600-
	1 x 1	.709	3.465	7.087	2.603	1.603	C2A-RSA16-RFK18B-088DB	1.000	1.000	6.000	1.039	1.000	2175	3.3	1.515	C2I-K2N-0600-
	1 x 1	.709	6.614	15.748	2.603	1.603	C2A-RSA16-RFK18B-168DB	1.000	1.000	6.000	1.039	1.000	2175	3.3	1.510	C2I-K2N-0600-
	1 x 1	.709	8.661	39.370	2.603	1.603	C2A-RSA16-RFK18B-220DB	1.000	1.000	6.000	1.039	1.000	2175	3.3	1.508	C2I-K2N-0600-
L	1 x 1	.906	2.953	5.906	2.785	1.785	C2A-RSA16-RFL23B-075DB	1.000	1.000	6.000	1.063	1.000	2175	4.8	1.473	C2I-L2N-0800-
	1 x 1	.906	5.512	15.748	2.785	1.785	C2A-RSA16-RFL23B-140DB	1.000	1.000	6.000	1.063	1.000	2175	4.8	1.464	C2I-L2N-0800-
	1 1/4 x 1	.906	2.953	5.906	3.035	1.785	C2A-RSA20-RFL23B-075DB	1.250	1.250	6.000	1.309	1.250	2175	4.8	2.262	C2I-L2N-0800-
	1 1/4 x 1	.906	5.512	15.748	3.035	1.785	C2A-RSA20-RFL23B-140DB	1.250	1.250	6.000	1.309	1.250	2175	4.8	2.205	C2I-L2N-0800-

CoroCut® 2 shank tool for face grooving

Screw clamp design

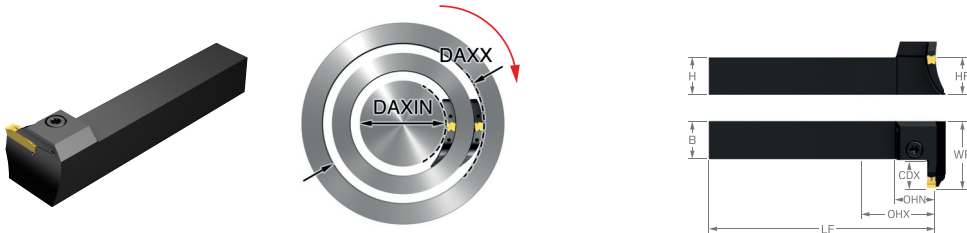

Metric version

SSC	CZC _{MS}	CDX	DAXIN	DAXX	OHX	OHN	Ordering code	Dimensions, mm							MID
								B	H	LF	WF	BAR	NM	KG	
H	25 x 25	18.0	40.0	60.0	49.6	24.6	C2A-RS25-LGH18B-040DB	25.0	25.0	150.0	45.0	150	4.5	0.78	C2I-H2N-0400-
	25 x 25	18.0	52.0	72.0	49.6	24.6	C2A-RS25-LGH18B-052DB	25.0	25.0	150.0	45.0	150	4.5	0.78	C2I-H2N-0400-
	25 x 25	18.0	64.0	100.0	49.6	24.6	C2A-RS25-LGH18B-064DB	25.0	25.0	150.0	45.0	150	4.5	0.77	C2I-H2N-0400-
	25 x 25	18.0	92.0	140.0	49.6	24.6	C2A-RS25-LGH18B-092DB	25.0	25.0	150.0	45.0	150	4.5	0.77	C2I-H2N-0400-
	25 x 25	18.0	132.0	230.0	49.6	24.6	C2A-RS25-LGH18B-132DB	25.0	25.0	150.0	45.0	150	4.5	0.77	C2I-H2N-0400-
	25 x 25	18.0	220.0	500.0	49.6	24.6	C2A-RS25-LGH18B-220DB	25.0	25.0	150.0	45.0	150	4.5	0.76	C2I-H2N-0400-
K	25 x 25	18.0	300.0	1100.0	49.6	24.6	C2A-RS25-LGH18B-300DB	25.0	25.0	150.0	45.0	150	4.5	0.76	C2I-H2N-0400-
	25 x 25	18.0	58.0	100.0	51.6	26.6	C2A-RS25-LGK18B-058DB	25.0	25.0	150.0	45.0	150	4.5	0.78	C2I-K2N-0600-
	25 x 25	18.0	88.0	180.0	51.6	26.6	C2A-RS25-LGK18B-088DB	25.0	25.0	150.0	45.0	150	4.5	0.77	C2I-K2N-0600-
L	25 x 25	18.0	168.0	400.0	51.6	26.6	C2A-RS25-LGK18B-168DB	25.0	25.0	150.0	45.0	150	4.5	0.77	C2I-K2N-0600-
	25 x 25	20.0	50.0	80.0	52.6	27.6	C2A-RS25-LGL20B-050DB	25.0	25.0	150.0	47.0	150	6.5	0.79	C2I-L2N-0800-
	25 x 25	20.0	75.0	150.0	52.6	27.6	C2A-RS25-LGL20B-075DB	25.0	25.0	150.0	47.0	150	6.5	0.77	C2I-L2N-0800-
	25 x 25	20.0	140.0	400.0	52.6	27.6	C2A-RS25-LGL20B-140DB	25.0	25.0	150.0	47.0	150	6.5	0.77	C2I-L2N-0800-

Inch version

SSC	CZC _{MS}	CDX	DAXIN	DAXX	OHX	OHN	Ordering code	Dimensions, inch							MID	
								B	H	LF	WF	HF	PSI	FT/LBS		LBS
H	1 x 1	.709	1.575	2.362	1.969	.969	C2A-RSA16-LGH18B-040DB	1.000	1.000	6.000	1.788	1.000	2175	3.3	1.801	C2I-H2N-0400-
	1 x 1	.709	2.047	2.835	1.969	.969	C2A-RSA16-LGH18B-052DB	1.000	1.000	6.000	1.788	1.000	2175	3.3	1.799	C2I-H2N-0400-
	1 x 1	.709	2.520	3.937	1.969	.969	C2A-RSA16-LGH18B-064DB	1.000	1.000	6.000	1.788	1.000	2175	3.3	1.781	C2I-H2N-0400-
	1 x 1	.709	3.622	5.512	1.969	.969	C2A-RSA16-LGH18B-092DB	1.000	1.000	6.000	1.788	1.000	2175	3.3	1.775	C2I-H2N-0400-
	1 x 1	.709	5.197	9.055	1.969	.969	C2A-RSA16-LGH18B-132DB	1.000	1.000	6.000	1.788	1.000	2175	3.3	1.766	C2I-H2N-0400-
	1 x 1	.709	8.661	19.685	1.969	.969	C2A-RSA16-LGH18B-220DB	1.000	1.000	6.000	1.788	1.000	2175	3.3	1.759	C2I-H2N-0400-
K	1 x 1	.709	11.811	43.307	1.969	.969	C2A-RSA16-LGH18B-300DB	1.000	1.000	6.000	1.788	1.000	2175	3.3	1.757	C2I-H2N-0400-
	1 x 1	.709	2.283	3.937	2.047	1.047	C2A-RSA16-LGK18B-058DB	1.000	1.000	6.000	1.788	1.000	2175	3.3	1.803	C2I-K2N-0600-
	1 x 1	.709	3.465	7.087	2.047	1.047	C2A-RSA16-LGK18B-088DB	1.000	1.000	6.000	1.788	1.000	2175	3.3	1.788	C2I-K2N-0600-
L	1 x 1	.709	6.614	15.748	2.047	1.047	C2A-RSA16-LGK18B-168DB	1.000	1.000	6.000	1.788	1.000	2175	3.3	1.781	C2I-K2N-0600-
	1 x 1	.790	1.969	3.150	2.087	1.087	C2A-RSA16-LGL20B-050DB	1.000	1.000	6.000	1.869	1.000	2175	4.8	1.984	C2I-L2N-0800-
	1 x 1	.790	2.953	5.906	2.087	1.087	C2A-RSA16-LGL20B-075DB	1.000	1.000	6.000	1.869	1.000	2175	4.8	1.786	C2I-L2N-0800-
	1 x 1	.790	5.512	15.748	2.087	1.087	C2A-RSA16-LGL20B-140DB	1.000	1.000	6.000	1.869	1.000	2175	4.8	1.775	C2I-L2N-0800-

CoroCut® 2 shank tool for face grooving

Screw clamp design

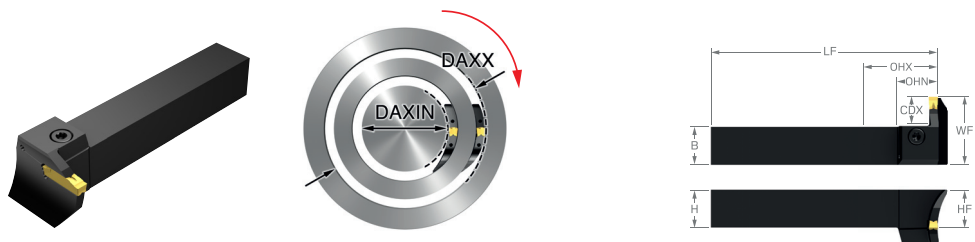

Metric version

SSC	CZC _{MS}	CDX	DAXIN	DAXX	OHX	OHN	Ordering code	Dimensions, mm							MIID
								B	H	LF	WF	BAR	NM	KG	
H	25 x 25	18.0	40.0	60.0	49.6	24.6	C2A-RS25-RGH18B-040DB	25.0	25.0	150.0	45.0	150	4.5	0.78	C2I-H2N-0400-
	25 x 25	18.0	52.0	72.0	49.6	24.6	C2A-RS25-RGH18B-052DB	25.0	25.0	150.0	45.0	150	4.5	0.78	C2I-H2N-0400-
	25 x 25	18.0	64.0	100.0	49.6	24.6	C2A-RS25-RGH18B-064DB	25.0	25.0	150.0	45.0	150	4.5	0.77	C2I-H2N-0400-
	25 x 25	18.0	92.0	140.0	49.6	24.6	C2A-RS25-RGH18B-092DB	25.0	25.0	150.0	45.0	150	4.5	0.77	C2I-H2N-0400-
	25 x 25	18.0	132.0	230.0	49.6	24.6	C2A-RS25-RGH18B-132DB	25.0	25.0	150.0	45.0	150	4.5	0.77	C2I-H2N-0400-
	25 x 25	18.0	220.0	500.0	49.6	24.6	C2A-RS25-RGH18B-220DB	25.0	25.0	150.0	45.0	150	4.5	0.76	C2I-H2N-0400-
K	25 x 25	18.0	300.0	1100.0	49.6	24.6	C2A-RS25-RGH18B-300DB	25.0	25.0	150.0	45.0	150	4.5	0.76	C2I-H2N-0400-
	25 x 25	18.0	58.0	100.0	51.6	26.6	C2A-RS25-RGK18B-058DB	25.0	25.0	150.0	45.0	150	4.5	0.78	C2I-K2N-0600-
	25 x 25	18.0	88.0	180.0	51.6	26.6	C2A-RS25-RGK18B-088DB	25.0	25.0	150.0	45.0	150	4.5	0.77	C2I-K2N-0600-
L	25 x 25	18.0	168.0	400.0	51.6	26.6	C2A-RS25-RGK18B-168DB	25.0	25.0	150.0	45.0	150	4.5	0.77	C2I-K2N-0600-
	25 x 25	20.0	50.0	80.0	52.6	27.6	C2A-RS25-RGL20B-050DB	25.0	25.0	150.0	47.0	150	6.5	0.79	C2I-L2N-0800-
	25 x 25	20.0	75.0	150.0	52.6	27.6	C2A-RS25-RGL20B-075DB	25.0	25.0	150.0	47.0	150	6.5	0.77	C2I-L2N-0800-
	25 x 25	20.0	140.0	400.0	52.6	27.6	C2A-RS25-RGL20B-140DB	25.0	25.0	150.0	47.0	150	6.5	0.77	C2I-L2N-0800-

Inch version

SSC	CZC _{MS}	CDX	DAXIN	DAXX	OHX	OHN	Ordering code	Dimensions, inch							MIID	
								B	H	LF	WF	HF	PSI	FT/LBS		LBS
H	1 x 1	.709	1.575	2.362	1.969	.969	C2A-RSA16-RGH18B-040DB	1.000	1.000	6.000	1.788	1.000	2175	3.3	1.801	C2I-H2N-0400-
	1 x 1	.709	2.047	2.835	1.969	.969	C2A-RSA16-RGH18B-052DB	1.000	1.000	6.000	1.788	1.000	2175	3.3	1.799	C2I-H2N-0400-
	1 x 1	.709	2.520	3.937	1.969	.969	C2A-RSA16-RGH18B-064DB	1.000	1.000	6.000	1.788	1.000	2175	3.3	1.781	C2I-H2N-0400-
	1 x 1	.709	3.622	5.512	1.969	.969	C2A-RSA16-RGH18B-092DB	1.000	1.000	6.000	1.788	1.000	2175	3.3	1.775	C2I-H2N-0400-
	1 x 1	.709	5.197	9.055	1.969	.969	C2A-RSA16-RGH18B-132DB	1.000	1.000	6.000	1.788	1.000	2175	3.3	1.766	C2I-H2N-0400-
	1 x 1	.709	8.661	19.685	1.969	.969	C2A-RSA16-RGH18B-220DB	1.000	1.000	6.000	1.788	1.000	2175	3.3	1.759	C2I-H2N-0400-
K	1 x 1	.709	11.811	43.307	1.969	.969	C2A-RSA16-RGH18B-300DB	1.000	1.000	6.000	1.788	1.000	2175	3.3	1.757	C2I-H2N-0400-
	1 x 1	.709	2.283	3.937	2.047	1.047	C2A-RSA16-RGK18B-058DB	1.000	1.000	6.000	1.788	1.000	2175	3.3	1.803	C2I-K2N-0600-
	1 x 1	.709	3.465	7.087	2.047	1.047	C2A-RSA16-RGK18B-088DB	1.000	1.000	6.000	1.788	1.000	2175	3.3	1.788	C2I-K2N-0600-
L	1 x 1	.709	6.614	15.748	2.047	1.047	C2A-RSA16-RGK18B-168DB	1.000	1.000	6.000	1.788	1.000	2175	3.3	1.781	C2I-K2N-0600-
	1 x 1	.790	1.969	3.150	2.087	1.087	C2A-RSA16-RGL20B-050DB	1.000	1.000	6.000	1.869	1.000	2175	4.8	1.814	C2I-L2N-0800-
	1 x 1	.790	2.953	5.906	2.087	1.087	C2A-RSA16-RGL20B-075DB	1.000	1.000	6.000	1.869	1.000	2175	4.8	1.786	C2I-L2N-0800-
	1 x 1	.790	5.512	15.748	2.087	1.087	C2A-RSA16-RGL20B-140DB	1.000	1.000	6.000	1.869	1.000	2175	4.8	1.775	C2I-L2N-0800-

CoroCut® 2 shank tool for profiling

Screw clamp design

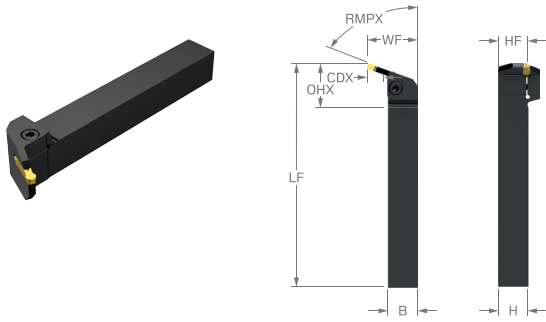

Metric version

	SSC	CZC _{MS}	CDX	RMPX	OHX	OHN	Ordering code	Dimensions, mm						MIID
								B	H	LF	WF	NM	KG	
	G	20 x 20	4.0	45°	54.3	34.3	C2T-RS20-R/LX45G04DB	20.0	20.0	150.0	25.6	4.0	0.44	C21-G2-0400-RM
		25 x 25	4.0	45°	59.3	34.3	C2T-RS25-R/LX45G04DB	25.0	25.0	150.0	30.6	4.0	0.67	C21-G2-0400-RM
	J	20 x 20	5.0	45°	60.9	40.9	C2T-RS20-R/LX45J05DB	20.0	20.0	150.0	26.6	4.5	0.45	C21-J2-0600-RM
		25 x 25	5.0	45°	65.9	40.9	C2T-RS25-R/LX45J05DB	25.0	25.0	150.0	31.6	4.5	0.68	C21-J2-0600-RM
	J	25 x 25	16.0	70°	60.1	35.1	C2T-RS25-R/LX70J16DB	25.0	25.0	190.0	42.6	4.5	0.90	C21-J2-0600-RM
		32 x 32	16.0	70°	67.1	35.1	C2T-RS32-R/LX70J16DB	32.0	32.0	190.0	49.6	4.5	1.46	C21-J2-0600-RM
	L	25 x 25	25.0	83°	73.3	48.3	C2T-RS25-R/LX07L25DB	25.0	25.0	190.0	32.0	6.5	0.86	C21-L2-0800-RM
		32 x 32	25.0	83°	80.3	48.3	C2T-RS32-R/LX07L25DB	32.0	32.0	190.0	40.0	6.5	1.37	C21-L2-0800-RM



Inch version

	SSC	CZC _{MS}	CDX	RMPX	OHX	OHN	Ordering code	Dimensions, inch						MIID	
								B	H	LF	WF	HF	FT/LBS		LBS
	G	3/4 x 3/4	.160	45°	2.099	1.349	C2T-RSA12-RX45G016DB	.750	.750	6.000	.973	.750	3.0	.895	C21-G2-0400-RM
		1 x 1	.160	45°	2.349	1.349	C2T-RSA16-R/LX45G016DB	1.000	1.000	6.000	1.223	1.000	3.0	1.534	C21-G2-0400-RM
	J	3/4 x 3/4	.200	45°	2.362	1.612	C2T-RSA12-R/LX45J020DB	.750	.750	6.000	1.013	.750	3.3	.913	C21-J2-0600-RM
		1 x 1	.200	45°	2.612	1.612	C2T-RSA16-R/LX45J020DB	1.000	1.000	6.000	1.263	1.000	3.3	1.561	C21-J2-0600-RM
	J	1 1/4 x 1	.200	45°	2.862	1.612	C2T-RSA20-R/LX45J020DB	1.250	1.250	6.000	1.513	1.250	3.3	2.355	C21-J2-0600-RM
		1 x 1	.620	70°	2.381	1.381	C2T-RSA16-R/LX70J062DB	1.000	1.000	7.500	1.683	1.000	3.3	2.061	C21-J2-0600-RM
	J	1 1/4 x 1	.620	70°	2.631	1.381	C2T-RSA20-R/LX70J062DB	1.250	1.250	7.500	1.933	1.250	3.3	3.175	C21-J2-0600-RM

CoroCut® 2 shank tool for profiling

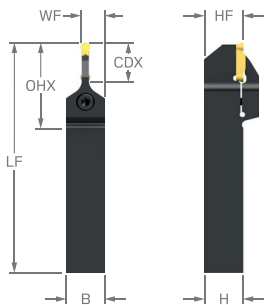
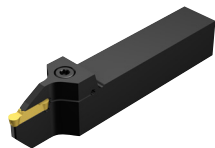
Screw clamp design



		Dimensions, mm												
SSC	CZC _{MS}	CDX	RMPX	OHX	OHN	Ordering code	B	H	LF	WF	NM	KG	MIID	
	G	20 x 20	18.0	90°	63.8	43.8	C2T-RS20-N18GDB	20.0	20.0	150.0	12.0	4.5	0.41	C2I-G2-0400-RM
		25 x 25	18.0	90°	68.8	43.8	C2T-RS25-N18GDB	25.0	25.0	150.0	14.5	4.5	0.63	C2I-G2-0400-RM
	J	25 x 25	25.0	90°	78.1	53.1	C2T-RS25-N25JDB	25.0	25.0	150.0	15.5	5.5	0.61	C2I-J2-0600-RM
		32 x 32	25.0	90°	85.1	53.1	C2T-RS32-N25JDB	32.0	32.0	170.0	19.0	5.5	1.13	C2I-J2-0600-RM

CoroCut® 2 cutting head for parting and grooving

Screw clamp design

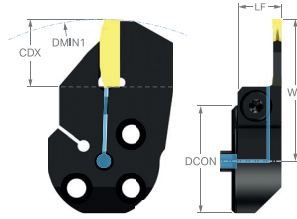
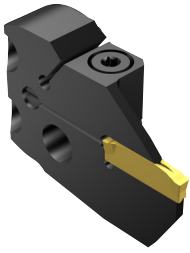

								Ordering code	Dimensions, mm					MIID	
	SSC	CZC _{MS}	CDX ₁	DMIN ₁	RMPX	OHX	CNSC		DCON _{MS}	LF	WF	BAR	NM		KG
	D	25	12.0	139.0	90°	14.0	1	C2R-SL25-R/LD12GB	25	14.0	30.9	150	2.0	0.05	C2I-D2N-0150-
		32	12.0	139.0	90°	14.0	1	C2R-SL32-R/LD12GB	32	14.0	34.4	150	2.0	0.08	C2I-D2N-0150-
		40	12.0	139.0	90°	14.0	1	C2R-SL40-R/LD12GB	40	14.0	38.0	150	2.0	0.13	C2I-D2N-0150-
	H	32	23.0	92.0	90°	18.0	1	C2R-SL32-R/LH23GB	32	18.0	46.1	150	3.0	0.12	C2I-H2N-0400-
		40	23.0	92.0	90°	18.0	1	C2R-SL40-R/LH23GB	40	18.0	50.1	150	3.0	0.18	C2I-H2N-0400-
	J	32	18.0	92.0	90°	18.0	1	C2R-SL32-R/LJ18GB	32	18.0	41.1	150	4.0	0.11	C2I-J2N-0500-
		40	18.0	92.0	90°	18.0	1	C2R-SL40-R/LJ18GB	40	18.0	45.1	150	3.0	0.17	C2I-J2N-0500-
	K	40	18.0	92.0	90°	18.0	1	C2R-SL40-R/LK18GB	40	18.0	45.1	150	4.0	0.18	C2I-K2N-0600-

ENG

CoroCut® 2 cutting head for parting and grooving

Screw clamp design

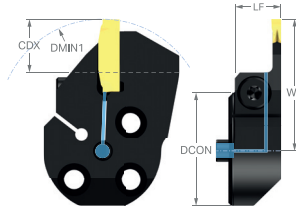
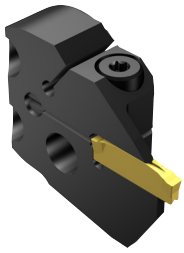

								Dimensions, mm						
SSC	CZC _{MS}	CDX ₁	DMIN ₁	RMPX	OHX	CNSC	Ordering code	DCON _{MS}	LF	WF	BAR	NM	KG	MIID
J	32	18.0	83.0	90°	18.0	1	C2R-SL32-R/LJ18GC	32	18.0	41.1	150	3.0	0.11	C2I-J2N-0500-
K	40	17.0	87.0	90°	18.0	1	C2R-SL40-R/LK17GC	40	18.0	44.1	150	2.5	0.17	C2I-K2N-0600-

CoroCut® 2 cutting head for parting and grooving

Screw clamp design

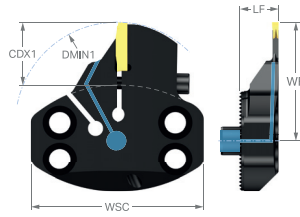

								Ordering code	Dimensions, mm						MIID
	SSC	CZC _{MS}	CDX ₁	DMIN ₁	DAXIN	OHX	CNSC		LF	WF	WSC	BAR	NM	KG	
	H	70	30.0	100.0	792.0	14.0	1	C2R-SL70-R/LH30AB	16.0	56.0	70.0	80	4.5	0.26	C2I-H2N-0400-
	K	70	30.0	120.0	308.0	14.0	1	C2R-SL70-R/LK30AB	17.0	55.0	70.0	80	4.5	0.28	C2I-K2N-0600-
		70	45.0	120.0	308.0	15.0	1	C2R-SL70-R/LK45AB	18.0	71.0	70.0	80	6.0	0.31	C2I-K2N-0600-
	L	70	35.0	90.0	254.0	14.0	1	C2R-SL70-R/LL35AB	18.0	61.0	70.0	80	6.5	0.30	C2I-L2-0800-RM
		70	50.0	105.0	324.0	14.0	1	C2R-SL70-R/LL50AB	18.0	81.0	70.0	80	6.5	0.35	C2I-L2-0800-RM
	J	70	15.0	120.0	308.0	15.0	1	C2R-SL70-R/LK15AB	18.0	36.0	70.0	80	2.0	0.26	C2I-J2-0600-RM

CoroCut® 2 cutting head for face grooving

Screw clamp design

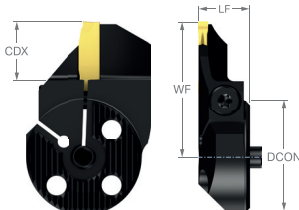
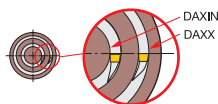
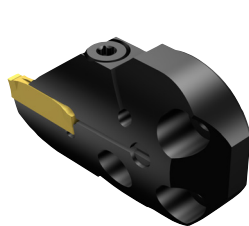

SSC	CZC _{MS}	CDX	DAXIN	DAXX	CNSC	Ordering code	Dimensions, mm, inch							MIID
							DCON _{MS}	LF	WF	HF	OAH	NM	KG	
H	32	18.0	40.0	60.0	1	C2A-SL32-LGH18A-040GB	32	18.0	41.1	0.1	36.0	3.0	0.10	C2I-H2N-0400-
		.709	1.575	2.362			1.260	.709	1.618	.004	1.417			
	32	18.0	52.0	72.0	1	C2A-SL32-LGH18A-052GB	32	18.0	41.1	0.1	36.0	3.0	0.10	C2I-H2N-0400-
		.709	2.047	2.835			1.260	.709	1.618	.004	1.417			
	32	18.0	64.0	100.0	1	C2A-SL32-LGH18A-064GB	32	18.0	41.1	0.1	36.0	3.0	0.10	C2I-H2N-0400-
		.709	2.520	3.937			1.260	.709	1.618	.004	1.417			
	32	18.0	92.0	140.0	1	C2A-SL32-LGH18A-092GB	32	18.0	41.1	0.1	36.0	3.0	0.10	C2I-H2N-0400-
		.709	3.622	5.512			1.260	.709	1.618	.004	1.417			
	32	18.0	132.0	230.0	1	C2A-SL32-LGH18A-132GB	32	18.0	41.1	0.1	36.0	3.0	0.10	C2I-H2N-0400-
		.709	5.197	9.055			1.260	.709	1.618	.004	1.417			
	32	18.0	220.0	500.0	1	C2A-SL32-LGH18A-220GB	32	18.0	41.1	0.1	36.0	3.0	0.11	C2I-H2N-0400-
		.709	8.661	19.685			1.260	.709	1.618	.004	1.417			
	32	18.0	300.0	800.0	1	C2A-SL32-LGH18A-300GB	32	18.0	41.1	0.1	36.0	3.0	0.11	C2I-H2N-0400-
		.709	11.811	31.496			1.260	.709	1.618	.004	1.417			
	40	18.0	40.0	60.0	1	C2A-SL40-LGH18A-040GB	40	18.0	45.1	0.1	45.0	3.0	0.14	C2I-H2N-0400-
		.709	1.575	2.362			1.575	.709	1.776	.004	1.771			
	40	18.0	52.0	72.0	1	C2A-SL40-LGH18A-052GB	40	18.0	45.1	0.1	45.0	3.0	0.15	C2I-H2N-0400-
		.709	2.047	2.835			1.575	.709	1.776	.004	1.771			
	40	18.0	64.0	100.0	1	C2A-SL40-LGH18A-064GB	40	18.0	45.1	0.1	45.0	3.0	0.15	C2I-H2N-0400-
		.709	2.520	3.937			1.575	.709	1.776	.004	1.771			
40	18.0	92.0	140.0	1	C2A-SL40-LGH18A-092GB	40	18.0	45.1	0.1	45.0	3.0	0.16	C2I-H2N-0400-	
	.709	3.622	5.512			1.575	.709	1.776	.004	1.771				
40	18.0	132.0	230.0	1	C2A-SL40-LGH18A-132GB	40	18.0	45.1	0.1	45.0	3.0	0.16	C2I-H2N-0400-	
	.709	5.197	9.055			1.575	.709	1.776	.004	1.771				
40	18.0	220.0	500.0	1	C2A-SL40-LGH18A-220GB	40	18.0	45.1	0.1	45.0	3.0	0.16	C2I-H2N-0400-	
	.709	8.661	19.685			1.575	.709	1.776	.004	1.771				
40	18.0	300.0	800.0	1	C2A-SL40-LGH18A-300GB	40	18.0	45.1	0.1	45.0	3.0	0.16	C2I-H2N-0400-	
	.709	11.811	31.496			1.575	.709	1.776	.004	1.771				
J	32	18.0	40.0	70.0	1	C2A-SL32-LGJ18A-040GB	32	18.0	41.1	0.1	36.0	3.5	0.10	C2I-J2N-0500-
		.709	1.575	2.756			1.260	.709	1.618	.004	1.417			
	32	18.0	60.0	95.0	1	C2A-SL32-LGJ18A-060GB	32	18.0	41.1	0.1	36.0	3.5	0.10	C2I-J2N-0500-
		.709	2.362	3.740			1.260	.709	1.618	.004	1.417			
	32	18.0	85.0	130.0	1	C2A-SL32-LGJ18A-085GB	32	18.0	41.1	0.1	36.0	3.5	0.10	C2I-J2N-0500-
		.709	3.346	5.118			1.260	.709	1.618	.004	1.417			
	32	18.0	120.0	180.0	1	C2A-SL32-LGJ18A-120GB	32	18.0	41.1	0.1	36.0	3.5	0.11	C2I-J2N-0500-
		.709	4.724	7.087			1.260	.709	1.618	.004	1.417			
	32	18.0	175.0	500.0	1	C2A-SL32-LGJ18A-175GB	32	18.0	41.1	0.1	36.0	3.5	0.11	C2I-J2N-0500-
		.709	6.890	19.685			1.260	.709	1.618	.004	1.417			
	32	18.0	180.0	980.0	1	C2A-SL32-LGJ18A-180GB	32	18.0	41.1	0.1	36.0	3.5	0.11	C2I-J2N-0500-
		.709	7.087	38.583			1.260	.709	1.618	.004	1.417			
	40	18.0	40.0	70.0	1	C2A-SL40-LGJ18A-040GB	40	18.0	45.1	0.1	45.0	3.5	0.14	C2I-J2N-0500-
		.709	1.575	2.756			1.575	.709	1.776	.004	1.771			
	40	18.0	60.0	95.0	1	C2A-SL40-LGJ18A-060GB	40	18.0	45.1	0.1	45.0	3.5	0.15	C2I-J2N-0500-
		.709	2.362	3.740			1.575	.709	1.776	.004	1.771			
	40	18.0	85.0	130.0	1	C2A-SL40-LGJ18A-085GB	40	18.0	45.1	0.1	45.0	3.5	0.16	C2I-J2N-0500-
		.709	3.346	5.118			1.575	.709	1.776	.004	1.771			
	40	18.0	120.0	180.0	1	C2A-SL40-LGJ18A-120GB	40	18.0	45.1	0.1	45.0	3.5	0.16	C2I-J2N-0500-
		.709	4.724	7.087			1.575	.709	1.776	.004	1.771			
40	18.0	175.0	500.0	1	C2A-SL40-LGJ18A-175GB	40	18.0	45.1	0.1	45.0	3.5	0.16	C2I-J2N-0500-	
	.709	6.890	19.685			1.575	.709	1.776	.004	1.771				
40	18.0	180.0	980.0	1	C2A-SL40-LGJ18A-180GB	40	18.0	45.1	0.1	45.0	3.5	0.16	C2I-J2N-0500-	
	.709	7.087	38.583			1.575	.709	1.776	.004	1.771				

CoroCut® 2 cutting head for face grooving

Screw clamp design

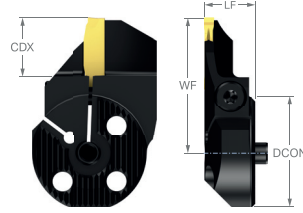
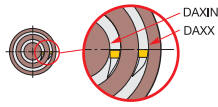

SSC	CZC _{MS}	CDX	DAXIN	DAXX	CNCS	Ordering code	Dimensions, mm, inch							MIID
							DCON _{MS}	LF	WF	HF	OAH	NM	KG	
K	32	18.0	88.0	180.0	1	C2A-SL32-LGK18A-088GB	32	18.0	41.1	0.1	36.0	4.0	0.11	C2I-K2N-0600-
		.709	3.465	7.087			1.260	.709	1.618	.004	1.417			
	32	18.0	220.0	1000.0	1	C2A-SL32-LGK18A-220GB	32	18.0	41.1	0.1	36.0	4.0	0.11	C2I-K2N-0600-
		.709	8.661	39.370			1.260	.709	1.618	.004	1.417			
	32	18.0	40.0	70.0	1	C2A-SL32-R/LGK18A-040GB	32	18.0	41.1	0.1	36.0	4.0	0.10	C2I-K2N-0600-
		.709	1.575	2.756			1.260	.709	1.618	.004	1.417			
	32	18.0	58.0	100.0	1	C2A-SL32-R/LGK18A-058GB	32	18.0	41.1	0.1	36.0	4.0	0.10	C2I-K2N-0600-
		.709	2.283	3.937			1.260	.709	1.618	.004	1.417			
	40	18.0	58.0	100.0	1	C2A-SL40-LGK18A-058GB	40	18.0	45.1	0.1	45.0	4.0	0.15	C2I-K2N-0600-
		.709	2.283	3.937			1.575	.709	1.776	.004	1.771			
	40	18.0	88.0	180.0	1	C2A-SL40-LGK18A-088GB	40	18.0	45.1	0.1	45.0	4.0	0.16	C2I-K2N-0600-
		.709	3.465	7.087			1.575	.709	1.776	.004	1.771			
40	18.0	168.0	400.0	1	C2A-SL40-LGK18A-168GB	40	18.0	45.1	0.1	45.0	4.0	0.17	C2I-K2N-0600-	
	.709	6.614	15.748			1.575	.709	1.776	.004	1.771				
40	18.0	220.0	1000.0	1	C2A-SL40-LGK18A-220GB	40	18.0	45.1	0.1	45.0	4.0	0.17	C2I-K2N-0600-	
	.709	8.661	39.370			1.575	.709	1.776	.004	1.771				
H	32	18.0	40.0	60.0	1	C2A-SL32-RGH18A-040GB	32	18.0	41.1	0.1	36.0	3.0	0.10	C2I-H2N-0400-
		.709	1.575	2.362			1.260	.709	1.618	.004	1.417			
	32	18.0	52.0	72.0	1	C2A-SL32-RGH18A-052GB	32	18.0	41.1	0.1	36.0	3.0	0.10	C2I-H2N-0400-
		.709	2.047	2.835			1.260	.709	1.618	.004	1.417			
	32	18.0	64.0	100.0	1	C2A-SL32-RGH18A-064GB	32	18.0	41.1	0.1	36.0	3.0	0.10	C2I-H2N-0400-
		.709	2.520	3.937			1.260	.709	1.618	.004	1.417			
	32	18.0	92.0	140.0	1	C2A-SL32-RGH18A-092GB	32	18.0	41.1	0.1	36.0	3.0	0.10	C2I-H2N-0400-
		.709	3.622	5.512			1.260	.709	1.618	.004	1.417			
	32	18.0	132.0	230.0	1	C2A-SL32-RGH18A-132GB	32	18.0	41.1	0.1	36.0	3.0	0.10	C2I-H2N-0400-
		.709	5.197	9.055			1.260	.709	1.618	.004	1.417			
	32	18.0	220.0	500.0	1	C2A-SL32-RGH18A-220GB	32	18.0	41.1	0.1	36.0	3.0	0.11	C2I-H2N-0400-
		.709	8.661	19.685			1.260	.709	1.618	.004	1.417			
	32	18.0	300.0	800.0	1	C2A-SL32-RGH18A-300GB	32	18.0	41.1	0.1	36.0	3.0	0.11	C2I-H2N-0400-
		.709	11.811	31.496			1.260	.709	1.618	.004	1.417			
	40	18.0	40.0	60.0	1	C2A-SL40-RGH18A-040GB	40	18.0	45.1	0.1	45.0	3.0	0.14	C2I-H2N-0400-
		.709	1.575	2.362			1.575	.709	1.776	.004	1.771			
	40	18.0	52.0	72.0	1	C2A-SL40-RGH18A-052GB	40	18.0	45.1	0.1	45.0	3.0	0.15	C2I-H2N-0400-
		.709	2.047	2.835			1.575	.709	1.776	.004	1.771			
	40	18.0	64.0	100.0	1	C2A-SL40-RGH18A-064GB	40	18.0	45.1	0.1	45.0	3.0	0.15	C2I-H2N-0400-
		.709	2.520	3.937			1.575	.709	1.776	.004	1.771			
	40	18.0	92.0	140.0	1	C2A-SL40-RGH18A-092GB	40	18.0	45.1	0.1	45.0	3.0	0.16	C2I-H2N-0400-
		.709	3.622	5.512			1.575	.709	1.776	.004	1.771			
	40	18.0	132.0	230.0	1	C2A-SL40-RGH18A-132GB	40	18.0	45.1	0.1	45.0	3.0	0.16	C2I-H2N-0400-
		.709	5.197	9.055			1.575	.709	1.776	.004	1.771			
40	18.0	220.0	500.0	1	C2A-SL40-RGH18A-220GB	40	18.0	45.1	0.1	45.0	3.0	0.16	C2I-H2N-0400-	
	.709	8.661	19.685			1.575	.709	1.776	.004	1.771				
40	18.0	300.0	800.0	1	C2A-SL40-RGH18A-300GB	40	18.0	45.1	0.1	45.0	3.0	0.16	C2I-H2N-0400-	
	.709	11.811	31.496			1.575	.709	1.776	.004	1.771				

CoroCut® 2 cutting head for face grooving

Screw clamp design

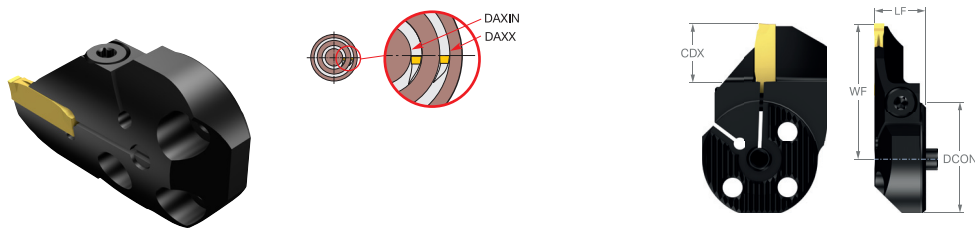

SSC	CZC _{MS}	CDX	DAXIN	DAXX	CNSC	Ordering code	Dimensions, mm, inch							MIID
							DCON _{MS}	LF	WF	HF	OAH	NM	KG	
J	32	18.0	40.0	70.0	1	C2A-SL32-RGJ18A-040GB	32	18.0	41.1	0.1	36.0	3.5	0.10	C2I-J2N-0500-
		.709	1.575	2.756			1.260	.709	1.618	.004	1.417			
	32	18.0	60.0	95.0	1	C2A-SL32-RGJ18A-060GB	32	18.0	41.1	0.1	36.0	3.5	0.10	C2I-J2N-0500-
		.709	2.362	3.740			1.260	.709	1.618	.004	1.417			
	32	18.0	85.0	130.0	1	C2A-SL32-RGJ18A-085GB	32	18.0	41.1	0.1	36.0	3.5	0.10	C2I-J2N-0500-
		.709	3.346	5.118			1.260	.709	1.618	.004	1.417			
	32	18.0	120.0	180.0	1	C2A-SL32-RGJ18A-120GB	32	18.0	41.1	0.1	36.0	3.5	0.11	C2I-J2N-0500-
		.709	4.724	7.087			1.260	.709	1.618	.004	1.417			
	32	18.0	175.0	500.0	1	C2A-SL32-RGJ18A-175GB	32	18.0	41.1	0.1	36.0	3.5	0.11	C2I-J2N-0500-
		.709	6.890	19.685			1.260	.709	1.618	.004	1.417			
	32	18.0	180.0	980.0	1	C2A-SL32-RGJ18A-180GB	32	18.0	41.1	0.1	36.0	3.5	0.11	C2I-J2N-0500-
		.709	7.087	38.583			1.260	.709	1.618	.004	1.417			
	40	18.0	40.0	70.0	1	C2A-SL40-RGJ18A-040GB	40	18.0	45.1	0.1	45.0	3.5	0.14	C2I-J2N-0500-
		.709	1.575	2.756			1.575	.709	1.776	.004	1.771			
	40	18.0	60.0	95.0	1	C2A-SL40-RGJ18A-060GB	40	18.0	45.1	0.1	45.0	3.5	0.15	C2I-J2N-0500-
		.709	2.362	3.740			1.575	.709	1.776	.004	1.771			
	40	18.0	85.0	130.0	1	C2A-SL40-RGJ18A-085GB	40	18.0	45.1	0.1	45.0	3.5	0.16	C2I-J2N-0500-
		.709	3.346	5.118			1.575	.709	1.776	.004	1.771			
	40	18.0	120.0	180.0	1	C2A-SL40-RGJ18A-120GB	40	18.0	45.1	0.1	45.0	3.5	0.16	C2I-J2N-0500-
		.709	4.724	7.087			1.575	.709	1.776	.004	1.771			
40	18.0	175.0	500.0	1	C2A-SL40-RGJ18A-175GB	40	18.0	45.1	0.1	45.0	3.5	0.16	C2I-J2N-0500-	
	.709	6.890	19.685			1.575	.709	1.776	.004	1.771				
40	18.0	180.0	980.0	1	C2A-SL40-RGJ18A-180GB	40	18.0	45.1	0.1	45.0	3.5	0.16	C2I-J2N-0500-	
	.709	7.087	38.583			1.575	.709	1.776	.004	1.771				
K	32	18.0	168.0	400.0	1	C2A-SL32-R/LGK18A-168GB	32	18.0	41.1	0.1	36.0	4.0	0.11	C2I-K2N-0600-
		.709	6.614	15.748			1.260	.709	1.618	.004	1.417			
	32	18.0	88.0	180.0	1	C2A-SL32-RGK18A-088GB	32	18.0	41.1	0.1	36.0	4.0	0.11	C2I-K2N-0600-
		.709	3.465	7.087			1.260	.709	1.618	.004	1.417			
	32	18.0	220.0	1000.0	1	C2A-SL32-RGK18A-220GB	32	18.0	41.1	0.1	36.0	4.0	0.11	C2I-K2N-0600-
		.709	8.661	39.370			1.260	.709	1.618	.004	1.417			
	40	18.0	40.0	70.0	1	C2A-SL40-R/LGK18A-040GB	40	18.0	45.1	0.1	45.0	4.0	0.14	C2I-K2N-0600-
		.709	1.575	2.756			1.575	.709	1.776	.004	1.771			
	40	18.0	58.0	100.0	1	C2A-SL40-RGK18A-058GB	40	18.0	45.1	0.1	45.0	4.0	0.15	C2I-K2N-0600-
		.709	2.283	3.937			1.575	.709	1.776	.004	1.771			
	40	18.0	88.0	180.0	1	C2A-SL40-RGK18A-088GB	40	18.0	45.1	0.1	45.0	4.0	0.16	C2I-K2N-0600-
		.709	3.465	7.087			1.575	.709	1.776	.004	1.771			
	40	18.0	168.0	400.0	1	C2A-SL40-RGK18A-168GB	40	18.0	45.1	0.1	45.0	4.0	0.17	C2I-K2N-0600-
		.709	6.614	15.748			1.575	.709	1.776	.004	1.771			
	40	18.0	220.0	1000.0	1	C2A-SL40-RGK18A-220GB	40	18.0	45.1	0.1	45.0	4.0	0.17	C2I-K2N-0600-
		.709	8.661	39.370			1.575	.709	1.776	.004	1.771			

CoroCut® 2 cutting head for face grooving

Screw clamp design

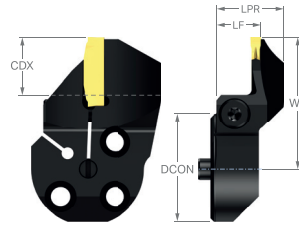
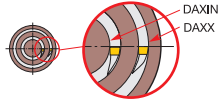
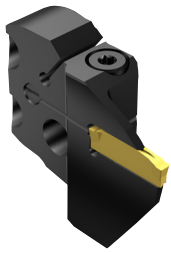

SSC	CZC _{MS}	CDX	DAXIN	DAXX	CNCS	Ordering code	Dimensions, mm, inch							MIID
							DCON _{MS}	LF	WF	HF	OAH	NM	KG	
H	32	18.0	40.0	60.0	1	C2A-SL32-LGH18B-040GB	32	18.0	41.1	0.1	36.0	3.0	0.11	C2I-H2N-0400-
		.709	1.575	2.362			1.260	.709	1.618	.004	1.417			
	32	18.0	52.0	72.0	1	C2A-SL32-LGH18B-052GB	32	18.0	41.1	0.1	36.0	3.0	0.11	C2I-H2N-0400-
		.709	2.047	2.835			1.260	.709	1.618	.004	1.417			
	32	18.0	64.0	100.0	1	C2A-SL32-LGH18B-064GB	32	18.0	41.1	0.1	36.0	3.0	0.11	C2I-H2N-0400-
		.709	2.520	3.937			1.260	.709	1.618	.004	1.417			
	32	18.0	92.0	140.0	1	C2A-SL32-LGH18B-092GB	32	18.0	41.1	0.1	36.0	3.0	0.11	C2I-H2N-0400-
		.709	3.622	5.512			1.260	.709	1.618	.004	1.417			
	32	18.0	132.0	230.0	1	C2A-SL32-LGH18B-132GB	32	18.0	41.1	0.1	36.0	3.0	0.11	C2I-H2N-0400-
		.709	5.197	9.055			1.260	.709	1.618	.004	1.417			
	32	18.0	220.0	500.0	1	C2A-SL32-LGH18B-220GB	32	18.0	41.1	0.1	36.0	3.0	0.11	C2I-H2N-0400-
		.709	8.661	19.685			1.260	.709	1.618	.004	1.417			
32	18.0	300.0	800.0	1	C2A-SL32-LGH18B-300GB	32	18.0	41.1	0.1	36.0	3.0	0.11	C2I-H2N-0400-	
	.709	11.811	31.496			1.260	.709	1.618	.004	1.417				
40	40	18.0	40.0	60.0	1	C2A-SL40-LGH18B-040GB	40	18.0	45.1	0.1	45.0	3.0	0.18	C2I-H2N-0400-
		.709	1.575	2.362			1.575	.709	1.776	.004	1.771			
	40	18.0	52.0	72.0	1	C2A-SL40-LGH18B-052GB	40	18.0	45.1	0.1	45.0	3.0	0.18	C2I-H2N-0400-
		.709	2.047	2.835			1.575	.709	1.776	.004	1.771			
	40	18.0	64.0	100.0	1	C2A-SL40-LGH18B-064GB	40	18.0	45.1	0.1	45.0	3.0	0.17	C2I-H2N-0400-
		.709	2.520	3.937			1.575	.709	1.776	.004	1.771			
	40	18.0	92.0	140.0	1	C2A-SL40-LGH18B-092GB	40	18.0	45.1	0.1	45.0	3.0	0.17	C2I-H2N-0400-
		.709	3.622	5.512			1.575	.709	1.776	.004	1.771			
	40	18.0	132.0	230.0	1	C2A-SL40-LGH18B-132GB	40	18.0	45.1	0.1	45.0	3.0	0.17	C2I-H2N-0400-
		.709	5.197	9.055			1.575	.709	1.776	.004	1.771			
	40	18.0	220.0	500.0	1	C2A-SL40-LGH18B-220GB	40	18.0	45.1	0.1	45.0	3.0	0.17	C2I-H2N-0400-
		.709	8.661	19.685			1.575	.709	1.776	.004	1.771			
40	18.0	300.0	800.0	1	C2A-SL40-LGH18B-300GB	40	18.0	45.1	0.1	45.0	3.0	0.17	C2I-H2N-0400-	
	.709	11.811	31.496			1.575	.709	1.776	.004	1.771				
J	32	18.0	40.0	70.0	1	C2A-SL32-LGJ18B-040GB	32	18.0	41.1	0.1	36.0	3.5	0.11	C2I-J2N-0500-
		.709	1.575	2.756			1.260	.709	1.618	.004	1.417			
	32	18.0	60.0	95.0	1	C2A-SL32-LGJ18B-060GB	32	18.0	41.1	0.1	36.0	3.5	0.11	C2I-J2N-0500-
		.709	2.362	3.740			1.260	.709	1.618	.004	1.417			
	32	18.0	85.0	130.0	1	C2A-SL32-LGJ18B-085GB	32	18.0	41.1	0.1	36.0	3.5	0.11	C2I-J2N-0500-
		.709	3.346	5.118			1.260	.709	1.618	.004	1.417			
	32	18.0	120.0	180.0	1	C2A-SL32-LGJ18B-120GB	32	18.0	41.1	0.1	36.0	3.5	0.11	C2I-J2N-0500-
		.709	4.724	7.087			1.260	.709	1.618	.004	1.417			
	32	18.0	175.0	500.0	1	C2A-SL32-LGJ18B-175GB	32	18.0	41.1	0.1	36.0	3.5	0.11	C2I-J2N-0500-
		.709	6.890	19.685			1.260	.709	1.618	.004	1.417			
	32	18.0	180.0	980.0	1	C2A-SL32-LGJ18B-180GB	32	18.0	41.1	0.1	36.0	3.5	0.11	C2I-J2N-0500-
		.709	7.087	38.583			1.260	.709	1.618	.004	1.417			
40	18.0	40.0	70.0	1	C2A-SL40-LGJ18B-040GB	40	18.0	45.1	0.1	45.0	3.5	0.18	C2I-J2N-0500-	
	.709	1.575	2.756			1.575	.709	1.776	.004	1.771				
40	18.0	60.0	95.0	1	C2A-SL40-LGJ18B-060GB	40	18.0	45.1	0.1	45.0	3.5	0.18	C2I-J2N-0500-	
	.709	2.362	3.740			1.575	.709	1.776	.004	1.771				
40	18.0	85.0	130.0	1	C2A-SL40-LGJ18B-085GB	40	18.0	45.1	0.1	45.0	3.5	0.18	C2I-J2N-0500-	
	.709	3.346	5.118			1.575	.709	1.776	.004	1.771				
40	18.0	120.0	180.0	1	C2A-SL40-LGJ18B-120GB	40	18.0	45.1	0.1	45.0	3.5	0.18	C2I-J2N-0500-	
	.709	4.724	7.087			1.575	.709	1.776	.004	1.771				
40	18.0	175.0	500.0	1	C2A-SL40-LGJ18B-175GB	40	18.0	45.1	0.1	45.0	3.5	0.17	C2I-J2N-0500-	
	.709	6.890	19.685			1.575	.709	1.776	.004	1.771				
40	18.0	180.0	980.0	1	C2A-SL40-LGJ18B-180GB	40	18.0	45.1	0.1	45.0	3.5	0.17	C2I-J2N-0500-	
	.709	7.087	38.583			1.575	.709	1.776	.004	1.771				

CoroCut® 2 cutting head for face grooving

Screw clamp design

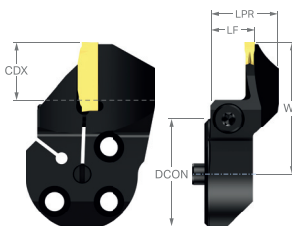
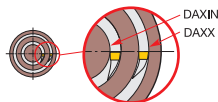
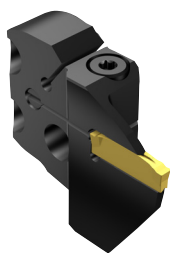

SSC	CZC _{MS}	CDX	DAXIN	DAXX	CNSC	Ordering code	Dimensions, mm, inch							MIID
							DCON _{MS}	LF	WF	HF	OAH	NM	KG	
K	32	18.0	40.0	70.0	1	C2A-SL32-LGK18B-040GB	32	18.0	41.1	0.1	36.0	4.0	0.12	C2I-K2N-0600-
		.709	1.575	2.756			1.260	.709	1.618	.004	1.417			
	32	18.0	58.0	100.0	1	C2A-SL32-LGK18B-058GB	32	18.0	41.1	0.1	36.0	4.0	0.11	C2I-K2N-0600-
		.709	2.283	3.937			1.260	.709	1.618	.004	1.417			
	32	18.0	88.0	180.0	1	C2A-SL32-LGK18B-088GB	32	18.0	41.1	0.1	36.0	4.0	0.11	C2I-K2N-0600-
		.709	3.465	7.087			1.260	.709	1.618	.004	1.417			
	32	18.0	168.0	400.0	1	C2A-SL32-LGK18B-168GB	32	18.0	41.1	0.1	36.0	4.0	0.11	C2I-K2N-0600-
		.709	6.614	15.748			1.260	.709	1.618	.004	1.417			
	32	18.0	220.0	1000.0	1	C2A-SL32-LGK18B-220GB	32	18.0	41.1	0.1	36.0	4.0	0.11	C2I-K2N-0600-
		.709	8.661	39.370			1.260	.709	1.618	.004	1.417			
	40	18.0	40.0	70.0	1	C2A-SL40-LGK18B-040GB	40	18.0	45.1	0.1	45.0	4.0	0.18	C2I-K2N-0600-
		.709	1.575	2.756			1.575	.709	1.776	.004	1.771			
40	18.0	58.0	100.0	1	C2A-SL40-LGK18B-058GB	40	18.0	45.1	0.1	45.0	4.0	0.18	C2I-K2N-0600-	
	.709	2.283	3.937			1.575	.709	1.776	.004	1.771				
40	18.0	88.0	180.0	1	C2A-SL40-LGK18B-088GB	40	18.0	45.1	0.1	45.0	4.0	0.18	C2I-K2N-0600-	
	.709	3.465	7.087			1.575	.709	1.776	.004	1.771				
40	18.0	168.0	400.0	1	C2A-SL40-LGK18B-168GB	40	18.0	45.1	0.1	45.0	4.0	0.18	C2I-K2N-0600-	
	.709	6.614	15.748			1.575	.709	1.776	.004	1.771				
40	18.0	220.0	1000.0	1	C2A-SL40-LGK18B-220GB	40	18.0	45.1	0.1	45.0	4.0	0.17	C2I-K2N-0600-	
	.709	8.661	39.370			1.575	.709	1.776	.004	1.771				
H	32	18.0	40.0	60.0	1	C2A-SL32-RGH18B-040GB	32	18.0	41.1	0.1	36.0	3.0	0.11	C2I-H2N-0400-
		.709	1.575	2.362			1.260	.709	1.618	.004	1.417			
	32	18.0	52.0	72.0	1	C2A-SL32-RGH18B-052GB	32	18.0	41.1	0.1	36.0	3.0	0.11	C2I-H2N-0400-
		.709	2.047	2.835			1.260	.709	1.618	.004	1.417			
	32	18.0	64.0	100.0	1	C2A-SL32-RGH18B-064GB	32	18.0	41.1	0.1	36.0	3.0	0.11	C2I-H2N-0400-
		.709	2.520	3.937			1.260	.709	1.618	.004	1.417			
	32	18.0	92.0	140.0	1	C2A-SL32-RGH18B-092GB	32	18.0	41.1	0.1	36.0	3.0	0.11	C2I-H2N-0400-
		.709	3.622	5.512			1.260	.709	1.618	.004	1.417			
	32	18.0	132.0	230.0	1	C2A-SL32-RGH18B-132GB	32	18.0	41.1	0.1	36.0	3.0	0.11	C2I-H2N-0400-
		.709	5.197	9.055			1.260	.709	1.618	.004	1.417			
	32	18.0	220.0	500.0	1	C2A-SL32-RGH18B-220GB	32	18.0	41.1	0.1	36.0	3.0	0.11	C2I-H2N-0400-
		.709	8.661	19.685			1.260	.709	1.618	.004	1.417			
	32	18.0	300.0	800.0	1	C2A-SL32-RGH18B-300GB	32	18.0	41.1	0.1	36.0	3.0	0.11	C2I-H2N-0400-
		.709	11.811	31.496			1.260	.709	1.618	.004	1.417			
	40	18.0	40.0	60.0	1	C2A-SL40-RGH18B-040GB	40	18.0	45.1	0.1	45.0	3.0	0.18	C2I-H2N-0400-
		.709	1.575	2.362			1.575	.709	1.776	.004	1.771			
	40	18.0	52.0	72.0	1	C2A-SL40-RGH18B-052GB	40	18.0	45.1	0.1	45.0	3.0	0.18	C2I-H2N-0400-
		.709	2.047	2.835			1.575	.709	1.776	.004	1.771			
	40	18.0	64.0	100.0	1	C2A-SL40-RGH18B-064GB	40	18.0	45.1	0.1	45.0	3.0	0.17	C2I-H2N-0400-
		.709	2.520	3.937			1.575	.709	1.776	.004	1.771			
	40	18.0	92.0	140.0	1	C2A-SL40-RGH18B-092GB	40	18.0	45.1	0.1	45.0	3.0	0.17	C2I-H2N-0400-
		.709	3.622	5.512			1.575	.709	1.776	.004	1.771			
	40	18.0	132.0	230.0	1	C2A-SL40-RGH18B-132GB	40	18.0	45.1	0.1	45.0	3.0	0.17	C2I-H2N-0400-
		.709	5.197	9.055			1.575	.709	1.776	.004	1.771			
40	18.0	220.0	500.0	1	C2A-SL40-RGH18B-220GB	40	18.0	45.1	0.1	45.0	3.0	0.17	C2I-H2N-0400-	
	.709	8.661	19.685			1.575	.709	1.776	.004	1.771				
40	18.0	300.0	800.0	1	C2A-SL40-RGH18B-300GB	40	18.0	45.1	0.1	45.0	3.0	0.17	C2I-H2N-0400-	
	.709	11.811	31.496			1.575	.709	1.776	.004	1.771				

CoroCut® 2 cutting head for face grooving

Screw clamp design

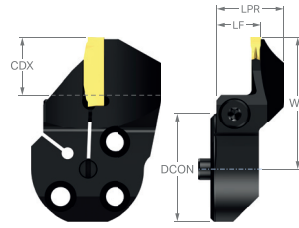
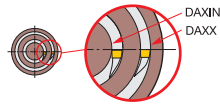
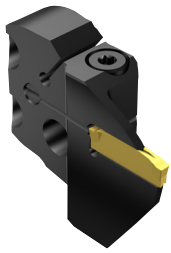

SSC	CZC _{MS}	CDX	DAXIN	DAXX	CN5C	Ordering code	Dimensions, mm, inch						MIID	
							DCON _{MS}	LF	WF	HF	OAH	NM		KG
J	32	18.0	40.0	70.0	1	C2A-SL32-RGJ18B-040GB	32	18.0	41.1	0.1	36.0	3.5	0.11	C2I-J2N-0500-
		.709	1.575	2.756			1.260	.709	1.618	.004	1.417			
	32	18.0	60.0	95.0	1	C2A-SL32-RGJ18B-060GB	32	18.0	41.1	0.1	36.0	3.5	0.11	C2I-J2N-0500-
		.709	2.362	3.740			1.260	.709	1.618	.004	1.417			
	32	18.0	85.0	130.0	1	C2A-SL32-RGJ18B-085GB	32	18.0	41.1	0.1	36.0	3.5	0.11	C2I-J2N-0500-
		.709	3.346	5.118			1.260	.709	1.618	.004	1.417			
	32	18.0	120.0	180.0	1	C2A-SL32-RGJ18B-120GB	32	18.0	41.1	0.1	36.0	3.5	0.11	C2I-J2N-0500-
		.709	4.724	7.087			1.260	.709	1.618	.004	1.417			
	32	18.0	175.0	500.0	1	C2A-SL32-RGJ18B-175GB	32	18.0	41.1	0.1	36.0	3.5	0.11	C2I-J2N-0500-
		.709	6.890	19.685			1.260	.709	1.618	.004	1.417			
	32	18.0	180.0	980.0	1	C2A-SL32-RGJ18B-180GB	32	18.0	41.1	0.1	36.0	3.5	0.11	C2I-J2N-0500-
		.709	7.087	38.583			1.260	.709	1.618	.004	1.417			
40	40	18.0	40.0	70.0	1	C2A-SL40-RGJ18B-040GB	40	18.0	45.1	0.1	45.0	3.5	0.18	C2I-J2N-0500-
		.709	1.575	2.756			1.575	.709	1.776	.004	1.771			
	40	18.0	60.0	95.0	1	C2A-SL40-RGJ18B-060GB	40	18.0	45.1	0.1	45.0	3.5	0.18	C2I-J2N-0500-
		.709	2.362	3.740			1.575	.709	1.776	.004	1.771			
	40	18.0	85.0	130.0	1	C2A-SL40-RGJ18B-085GB	40	18.0	45.1	0.1	45.0	3.5	0.18	C2I-J2N-0500-
		.709	3.346	5.118			1.575	.709	1.776	.004	1.771			
	40	18.0	120.0	180.0	1	C2A-SL40-RGJ18B-120GB	40	18.0	45.1	0.1	45.0	3.5	0.18	C2I-J2N-0500-
		.709	4.724	7.087			1.575	.709	1.776	.004	1.771			
	40	18.0	175.0	500.0	1	C2A-SL40-RGJ18B-175GB	40	18.0	45.1	0.1	45.0	3.5	0.17	C2I-J2N-0500-
		.709	6.890	19.685			1.575	.709	1.776	.004	1.771			
	40	18.0	180.0	980.0	1	C2A-SL40-RGJ18B-180GB	40	18.0	45.1	0.1	45.0	3.5	0.17	C2I-J2N-0500-
		.709	7.087	38.583			1.575	.709	1.776	.004	1.771			
K	32	18.0	40.0	70.0	1	C2A-SL32-RGK18B-040GB	32	18.0	41.1	0.1	36.0	4.0	0.12	C2I-K2N-0600-
		.709	1.575	2.756			1.260	.709	1.618	.004	1.417			
	32	18.0	58.0	100.0	1	C2A-SL32-RGK18B-058GB	32	18.0	41.1	0.1	36.0	4.0	0.14	C2I-K2N-0600-
		.709	2.283	3.937			1.260	.709	1.618	.004	1.417			
	32	18.0	88.0	180.0	1	C2A-SL32-RGK18B-088GB	32	18.0	41.1	0.1	36.0	4.0	0.11	C2I-K2N-0600-
		.709	3.465	7.087			1.260	.709	1.618	.004	1.417			
	32	18.0	168.0	400.0	1	C2A-SL32-RGK18B-168GB	32	18.0	41.1	0.1	36.0	4.0	0.11	C2I-K2N-0600-
		.709	6.614	15.748			1.260	.709	1.618	.004	1.417			
	32	18.0	220.0	1000.0	1	C2A-SL32-RGK18B-220GB	32	18.0	41.1	0.1	36.0	4.0	0.11	C2I-K2N-0600-
		.709	8.661	39.370			1.260	.709	1.618	.004	1.417			
	40	18.0	40.0	70.0	1	C2A-SL40-RGK18B-040GB	40	18.0	45.1	0.1	45.0	4.0	0.18	C2I-K2N-0600-
		.709	1.575	2.756			1.575	.709	1.776	.004	1.771			
40	18.0	58.0	100.0	1	C2A-SL40-RGK18B-058GB	40	18.0	45.1	0.1	45.0	4.0	0.18	C2I-K2N-0600-	
	.709	2.283	3.937			1.575	.709	1.776	.004	1.771				
40	18.0	88.0	180.0	1	C2A-SL40-RGK18B-088GB	40	18.0	45.1	0.1	45.0	4.0	0.18	C2I-K2N-0600-	
	.709	3.465	7.087			1.575	.709	1.776	.004	1.771				
40	18.0	168.0	400.0	1	C2A-SL40-RGK18B-168GB	40	18.0	45.1	0.1	45.0	4.0	0.18	C2I-K2N-0600-	
	.709	6.614	15.748			1.575	.709	1.776	.004	1.771				
40	18.0	220.0	1000.0	1	C2A-SL40-RGK18B-220GB	40	18.0	45.1	0.1	45.0	4.0	0.17	C2I-K2N-0600-	
	.709	8.661	39.370			1.575	.709	1.776	.004	1.771				

CoroCut® 2 cutting head for face grooving

Screw clamp design

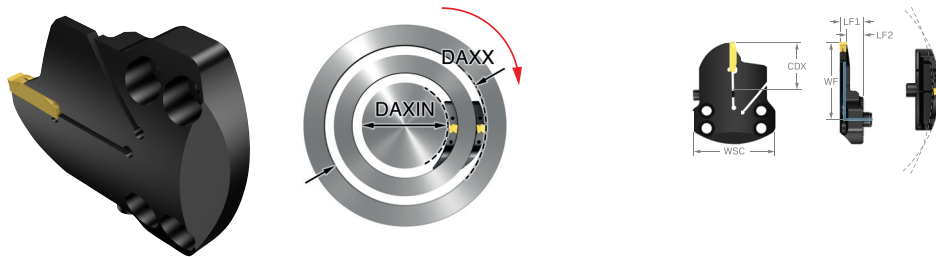

								Dimensions, mm, inch						
SSC	CZC _{MS}	CDX	DAXIN	DAXX	OHX	CNSC	Ordering code	LF	WF	HF	WSC	NM	KG	MIID
H	70	40.0	290.0	500.0	15.0	1	C2A-SL70-LGH40A-290AB	17.0	66.0	0.1	70.0	5.6	0.28	C2I-H2N-0400-
		1.575	11.417	19.685	.591			.669	2.598	.004	2.756			
J	70	40.0	290.0	500.0	15.0	1	C2A-SL70-LGJ40A-290AB	17.5	66.0	0.1	70.0	5.6	0.30	C2I-J2N-0500-
		1.575	11.417	19.685	.591			.689	2.598	.004	2.756			
K	70	40.0	168.0	300.0	17.0	1	C2A-SL70-LGK40A-168AB	20.0	66.0	0.1	70.0	5.6	0.34	C2I-K2N-0600-
		1.575	6.614	11.811	.669			.787	2.598	.004	2.756			
	70	40.0	288.0	500.0	15.0	1	C2A-SL70-LGK40A-288AB	18.0	66.0	0.1	70.0	5.5	0.06	C2I-K2N-0600-
		1.575	11.339	19.685	.591			.709	2.598	.004	2.756			
H	70	40.0	290.0	500.0	15.0	1	C2A-SL70-RGH40A-290AB	17.0	66.0	0.1	70.0	5.6	0.28	C2I-H2N-0400-
		1.575	11.417	19.685	.591			.669	2.598	.004	2.756			
J	70	40.0	290.0	500.0	15.0	1	C2A-SL70-RGJ40A-290AB	17.5	66.0	0.1	70.0	5.6	0.30	C2I-J2N-0500-
		1.575	11.417	19.685	.591			.689	2.598	.004	2.756			
K	70	40.0	168.0	300.0	17.0	1	C2A-SL70-RGK40A-168AB	20.0	66.0	0.1	70.0	5.6	0.34	C2I-K2N-0600-
		1.575	6.614	11.811	.669			.787	2.598	.004	2.756			
	70	40.0	288.0	500.0	15.0	1	C2A-SL70-RGK40A-288AB	18.0	66.0	0.1	70.0	5.5	0.32	C2I-K2N-0600-
		1.575	11.339	19.685	.591			.709	2.598	.004	2.756			

CoroCut® 2 cutting head for face grooving

Screw clamp design

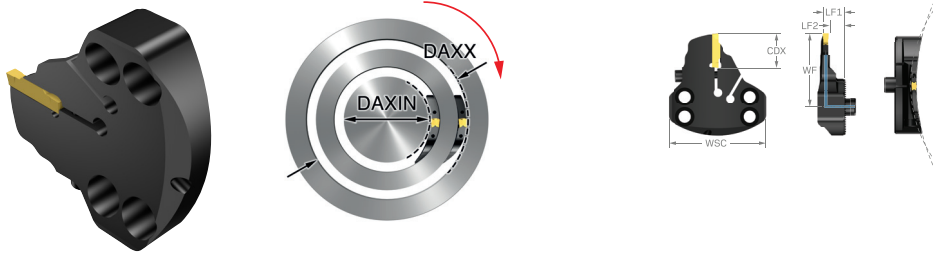

							Dimensions, mm, inch									
SSC	CZC _{MS}	CDX	DAXIN	DAXX	OHX	CNSC	Ordering code	LPR	LF	WF	HF	WSC	NM	KG	MIID	
H	70	15.0	80.0	130.0	13.0	1	C2A-SL70-LGH15B-080AB	18.7	15.0	53.0	0.1	70.0	4.0	0.26	C2I-H2N-0400-	
		.591	3.150	5.118	.512			.736	.591	2.087	.004	2.756				
		15.0	120.0	200.0	13.0	1	C2A-SL70-LGH15B-120AB	18.7	15.0	53.0	0.1	70.0	4.0	0.26	C2I-H2N-0400-	
	70	.591	4.724	7.874	.512			.736	.591	2.087	.004	2.756				
		15.0	190.0	300.0	13.0	1	C2A-SL70-LGH15B-190AB	18.7	15.0	53.0	0.1	70.0	4.0	0.25	C2I-H2N-0400-	
		.591	7.480	11.811	.512			.736	.591	2.087	.004	2.756				
	70	40.0	290.0	500.0	15.0	1	C2A-SL70-LGH40B-290AB	18.3	17.0	66.0	0.1	70.0	5.6	0.29	C2I-H2N-0400-	
		1.575	11.417	19.685	.591			.720	.669	2.598	.004	2.756				
		40.0	290.0	500.0	15.0	1	C2A-SL70-LGJ40B-290AB	18.3	17.5	66.0	0.1	70.0	5.6	0.32	C2I-J2N-0500-	
	J	1.575	11.417	19.685	.591			.720	.689	2.598	.004	2.756				
		70	40.0	168.0	300.0	15.0	1	C2A-SL70-LGK40B-168AB	20.0	18.0	66.0	0.1	70.0	5.5	0.35	C2I-K2N-0600-
			1.575	6.614	11.811	.591			.787	.709	2.598	.004	2.756			
40.0	288.0		500.0	15.0	1	C2A-SL70-LGK40B-288AB	19.2	18.0	66.0	0.1	70.0	5.5	0.34	C2I-K2N-0600-		
K	1.575	11.339	19.685	.591			.756	.709	2.598	.004	2.756					
	H	15.0	80.0	130.0	13.0	1	C2A-SL70-RGH15B-080AB	18.7	15.0	53.0	0.1	70.0	4.0	0.26	C2I-H2N-0400-	
		.591	3.150	5.118	.512			.736	.591	2.087	.004	2.756				
15.0		120.0	200.0	13.0	1	C2A-SL70-RGH15B-120AB	18.7	15.0	53.0	0.1	70.0	4.0	0.26	C2I-H2N-0400-		
70	.591	4.724	7.874	.512			.736	.591	2.087	.004	2.756					
	15.0	190.0	300.0	13.0	1	C2A-SL70-RGH15B-190AB	18.7	15.0	53.0	0.1	70.0	4.0	0.25	C2I-H2N-0400-		
	.591	7.480	11.811	.512			.736	.591	2.087	.004	2.756					
70	40.0	290.0	500.0	15.0	1	C2A-SL70-RGH40B-290AB	18.3	17.0	66.0	0.1	70.0	5.6	0.29	C2I-H2N-0400-		
	1.575	11.417	19.685	.591			.720	.669	2.598	.004	2.756					
	40.0	290.0	500.0	15.0	1	C2A-SL70-RGJ40B-290AB	18.3	17.5	66.0	0.1	70.0	5.6	0.32	C2I-J2N-0500-		
J	1.575	11.417	19.685	.591			.720	.689	2.598	.004	2.756					
	K	40.0	168.0	300.0	15.0	1	C2A-SL70-RGK40B-168AB	20.0	18.0	66.0	0.1	70.0	5.5	0.35	C2I-K2N-0600-	
		1.575	6.614	11.811	.591			.787	.709	2.598	.004	2.756				
40.0		288.0	500.0	15.0	1	C2A-SL70-RGK40B-288AB	19.2	18.0	66.0	0.1	70.0	5.5	0.34	C2I-K2N-0600-		
K	1.575	11.339	19.685	.591			.756	.709	2.598	.004	2.756					

CoroCut® 2 boring bar for grooving

Screw clamp design

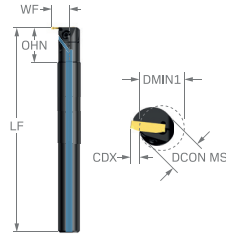
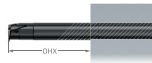

Metric version

SSC	CZC _{MS}	CDX ₁	DMIN ₁	OHX	OHN	CNCS	Ordering code	Dimensions, mm						MIID
								DCON _{MS}	LF	WF	BAR	NM	KG	
D	16	4.5	25.0	64.0	25.0	1	C2R-CE16-R/LD04GB	16	150.0	12.5	150	3.0	0.20	C2I-D2N-0150-
	20	5.0	32.0	80.0	30.0	1	C2R-CE20-R/LD05GB	20	180.0	15.3	150	3.0	0.39	C2I-D2N-0150-
E	20	5.0	32.0	80.0	30.0	1	C2R-CE20-R/LE05GB	20	180.0	15.3	150	3.5	0.39	C2I-E2N-0200-
	25	7.0	32.0	100.0	35.0	1	C2R-CE25-R/LE07GB	25	200.0	19.8	150	3.5	0.66	C2I-E2N-0200-
G	20	6.0	32.0	80.0	30.0	1	C2R-CE20-R/LG06GB	20	180.0	15.3	150	4.0	0.39	C2I-G2N-0300-
	25	7.0	32.0	100.0	35.0	1	C2R-CE25-R/LG07GB	25	200.0	19.8	150	4.0	0.66	C2I-G2N-0300-
H	25	7.0	32.0	100.0	35.0	1	C2R-CE25-R/LH07GB	25	200.0	19.3	150	4.5	0.66	C2I-H2N-0400-
	J	25	8.0	32.0	100.0	35.0	1	C2R-CE25-R/LJ08GB	25	200.0	19.8	150	5.0	0.66

Inch version

SSC	CZC _{MS}	CDX ₁	DMIN ₁	OHX	OHN	CNCS	Ordering code	Dimensions, inch						MIID
								DCON _{MS}	LF	WF	PSI	FT/LBS	LBS	
D	5/8	.177	.984	2.500	.984	1	C2R-CEA10-R/LD04GB	.625	5.906	.492	2175	2.2	.425	C2I-D2N-0150-
	3/4	.197	1.260	3.000	1.181	1	C2R-CEA12-R/LD05GB	.750	7.087	.592	2175	2.2	.776	C2I-D2N-0150-
E	3/4	.197	1.260	3.000	1.181	1	C2R-CEA12-R/LE05GB	.750	7.087	.592	2175	2.6	.776	C2I-E2N-0200-
	1	.280	1.260	4.000	1.378	1	C2R-CEA16-R/LE07GB	1.000	7.874	.785	2175	2.6	1.508	C2I-E2N-0200-
G	3/4	.236	1.260	3.000	1.181	1	C2R-CEA12-R/LG06GB	.750	7.087	.600	2175	3.0	.774	C2I-G2N-0300-
	1	.276	1.260	4.000	1.378	1	C2R-CEA16-R/LG07GB	1.000	7.874	.778	2175	3.0	1.506	C2I-G2N-0300-
H	1	.276	1.260	4.000	1.378	1	C2R-CEA16-R/LH07GB	1.000	7.874	.758	2175	3.3	1.504	C2I-H2N-0400-
	J	1	.315	1.260	4.000	1.378	1	C2R-CEA16-R/LJ08GB	1.000	7.874	.778	2175	3.7	1.497

CoroCut® 2 boring bar for grooving

Screw clamp design

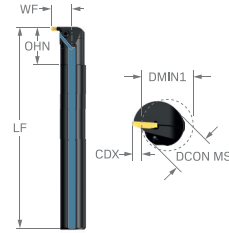
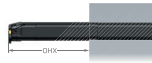

Metric version

SSC	CZC _{MS}	CDX ₁	DMIN ₁	OHX	OHN	CNCS	Ordering code	Dimensions, mm				BAR NM KG			MIID	
								DCON _{MS}	H	LF	WF					
	E	32	9.5	40.0	128.0	45.0	1	C2R-CF32-R/LE09GB	32	30.0	250.0	25.5	150	4.0	1.34	C2I-E2N-0200-
	G	32	9.0	40.0	128.0	45.0	1	C2R-CF32-R/LG09GB	32	30.0	250.0	25.3	150	4.5	1.34	C2I-G2N-0300-
		40	11.0	50.0	160.0	55.0	1	C2R-CF40-R/LG11GB	40	37.0	300.0	31.0	150	4.5	2.50	C2I-G2N-0300-
	H	32	10.0	40.0	128.0	45.0	1	C2R-CF32-R/LH10GB	32	30.0	250.0	26.5	150	4.5	1.33	C2I-H2N-0400-
		40	11.0	50.0	160.0	55.0	1	C2R-CF40-R/LH11GB	40	37.0	300.0	31.0	150	5.0	2.50	C2I-H2N-0400-
50		13.0	60.0	200.0	65.0	1	C2R-CF50-R/LH13GB	50	47.0	350.0	38.3	150	5.0	4.79	C2I-H2N-0400-	
J	32	11.0	40.0	128.0	45.0	1	C2R-CF32-R/LJ11GB	32	30.0	250.0	27.0	150	5.0	1.33	C2I-J2N-0500-	
	40	11.0	50.0	160.0	55.0	1	C2R-CF40-R/LJ11GB	40	37.0	300.0	31.0	150	5.5	2.50	C2I-J2N-0500-	
	50	13.0	60.0	200.0	65.0	1	C2R-CF50-R/LJ13GB	50	47.0	350.0	38.3	150	5.5	4.79	C2I-J2N-0500-	
K	40	11.0	50.0	160.0	55.0	1	C2R-CF40-R/LK11GB	40	37.0	300.0	31.0	150	5.5	2.51	C2I-K2N-0600-	
	50	13.0	60.0	200.0	65.0	1	C2R-CF50-R/LK13GB	50	47.0	350.0	38.3	150	5.5	4.80	C2I-K2N-0600-	

Inch version

SSC	CZC _{MS}	CDX ₁	DMIN ₁	OHX	OHN	CNCS	Ordering code	Dimensions, inch				PSI FT/LBS LBS			MIID	
								DCON _{MS}	H	LF	WF					
	E	1 1/4	.374	1.575	5.000	1.772	1	C2R-CFA20-R/LE09GB	1.250	1.181	9.843	1.014	2175	3.0	3.000	C2I-E2N-0200-
	G	1 1/4	.354	1.575	5.000	1.772	1	C2R-CFA20-R/LG09GB	1.250	1.181	9.843	1.014	2175	3.3	2.998	C2I-G2N-0300-
		1 1/2	.430	1.969	6.000	2.165	1	C2R-CFA24-R/LG11GB	1.500	1.374	11.811	1.189	2175	3.3	5.009	C2I-G2N-0300-
	H	1 1/4	.394	1.575	5.000	1.772	1	C2R-CFA20-R/LH10GB	1.250	1.181	9.843	1.053	2175	3.3	2.978	C2I-H2N-0400-
		1 1/2	.430	1.969	6.000	2.165	1	C2R-CFA24-R/LH11GB	1.500	1.374	11.811	1.221	2175	3.3	5.027	C2I-H2N-0400-
2		.512	2.362	8.000	2.559	1	C2R-CFA32-R/LH13GB	2.000	1.874	13.780	1.506	2175	3.7	10.873	C2I-H2N-0400-	
J	1 1/4	.433	1.575	5.000	1.772	1	C2R-CFA20-R/LJ11GB	1.250	1.181	9.843	1.073	2175	3.7	2.970	C2I-J2N-0500-	
	1 1/2	.433	1.969	6.000	2.165	1	C2R-CFA24-R/LJ11GB	1.500	1.374	11.811	1.189	2175	3.7	5.035	C2I-J2N-0500-	
	2	.512	2.362	8.000	2.559	1	C2R-CFA32-R/LJ13GB	2.000	1.874	13.780	1.524	2175	4.1	10.864	C2I-J2N-0500-	
K	1 1/2	.430	1.969	6.000	2.165	1	C2R-CFA24-R/LK11GB	1.500	1.374	11.811	1.189	2175	4.1	5.038	C2I-K2N-0600-	
	2	.512	2.362	8.000	2.559	1	C2R-CFA32-R/LK13GB	2.000	1.874	13.780	1.524	2175	4.1	10.867	C2I-K2N-0600-	

CoroCut® QD insert for parting

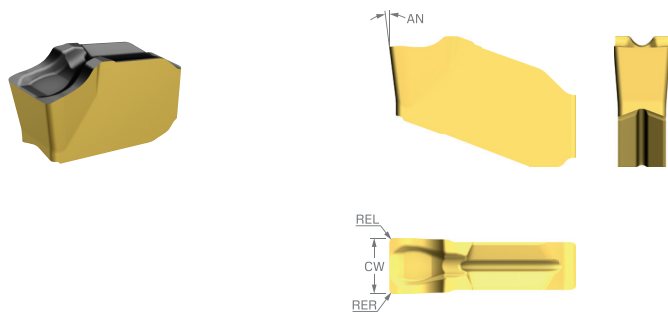

						P			M			K			N			S			Dimensions, mm, inch														
		SSC	CW	REL	RER	Ordering code															AN	CWTOLL	CWTOLU	RETOLL	RETOLU										
						1135	1145	1225	4425	1135	1145	1225	H13A	1135	1225	4425	H13A	1225	H13A	1135	1145	1225	H13A												
Roughing	E	2.00	0.30	0.30	0.30	QD-NE-0200-0003-CH	☆	☆	★		★	☆	☆	☆	☆	☆	☆	☆	☆	☆	☆	☆	☆	☆	☆	☆	☆	☆	7°	-0.050	0.050	-0.050	0.050		
		.079	.012	.012																															
	F	2.50	0.30	0.30	0.30	QD-NF-0250-0003-CH	☆	☆	★		★	☆	☆	☆	☆	☆	☆	☆	☆	☆	☆	☆	☆	☆	☆	☆	☆	7°	-0.050	0.050	-0.050	0.050			
		.098	.012	.012																															
	G	3.00	0.30	0.30	0.30	QD-NG-0300-0003-CH	☆	☆	★	☆	☆	☆	☆	☆	☆	☆	☆	☆	☆	☆	☆	☆	☆	☆	☆	☆	7°	-0.050	0.050	-0.050	0.050				
		.118	.012	.012																															
	H	4.00	0.30	0.30	0.30	QD-NH-0400-0003-CH	☆	☆	★	☆	☆	☆	☆	☆	☆	☆	☆	☆	☆	☆	☆	☆	☆	☆	☆	☆	7°	-0.050	0.050	-0.050	0.050				
		.157	.012	.012																															

CoroCut® QD blade for Y-axis parting

Spring clamp design

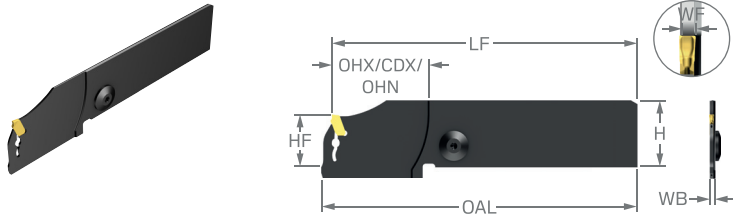

SSC	CZC _{MS}	CDX	OHX	CNCS	Ordering code	Dimensions, mm, inch					MIID
						H	LF	WF	HF	KG	
E	21	36.0	44.5	2	QD-NR1E36C21AY1	25.9	115.0	1.8	21.4	0.05	QD-NE-0200-0002-CM
		1.417	1.752			1.020	4.528	.069	.843		
	21	45.0	53.5	2	QD-NR1E45C21AY1	25.9	115.0	1.8	21.4	0.05	QD-NE-0200-0002-CM
		1.772	2.106			1.020	4.528	.069	.843		
	25	45.0	53.5	2	QD-NR1E45C25AY1	31.9	145.0	1.8	25.0	0.07	QD-NE-0200-0002-CM
		1.772	2.106			1.256	5.709	.069	.984		
25	60.0	68.5	2	QD-NR1E60C25AY1	31.9	145.0	1.8	25.0	0.07	QD-NE-0200-0002-CM	
	2.362	2.697			1.256	5.709	.069	.984			
F	21	36.0	44.5	2	QD-NR1F36C21AY1	25.9	115.0	2.3	21.4	0.05	QD-NF-0250-0002-CM
		1.417	1.752			1.020	4.528	.089	.843		
	21	45.0	53.5	2	QD-NR1F45C21AY1	25.9	115.0	2.3	21.4	0.05	QD-NF-0250-0002-CM
		1.772	2.106			1.020	4.528	.089	.843		
	25	60.0	53.5	2	QD-NR1F45C25AY1	31.9	145.0	2.3	25.0	0.08	QD-NF-0250-0002-CM
		2.362	2.106			1.256	5.709	.089	.984		
25	60.0	68.5	2	QD-NR1F60C25AY1	31.9	145.0	2.3	25.0	0.08	QD-NF-0250-0002-CM	
	2.362	2.697			1.256	5.709	.089	.984			
H	25	60.0	53.5	2	QD-NR1H45C25AY1	31.9	145.0	3.7	25.0	0.16	QD-NH-0400-0002-CM
		2.362	2.106			1.256	5.709	.145	.984		
	25	60.0	68.5	2	QD-NR1H60C25AY1	31.9	145.0	3.7	25.0	0.16	QD-NH-0400-0002-CM
		2.362	2.697			1.256	5.709	.145	.984		
J	25	60.0	69.0	2	QD-NR1J60C25AY1	31.9	144.5	4.7	25.0	0.17	QD-NJ-0500-0002-CM
		2.362	2.717			1.256	5.689	.184	.984		

ENG

CoroCut® QD blade for Y-axis parting

Spring clamp design

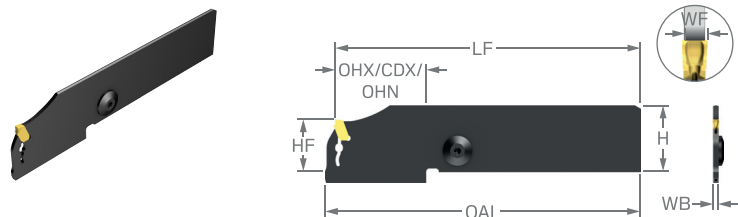

		Dimensions, mm, inch										
SSC	CZC _{MS}	CDX	OHX	CNCS	Ordering code						KG	MIID
						H	LF	WF	HF			
	G	21	36.0	44.5	2	QD-NN1G36C21AY1	25.9	115.0	2.7	21.4	0.06	QD-NG-0300-0002-CM
			1.417	1.752			1.020	4.528	.105	.843		
	21	45.0	53.5	2	QD-NN1G45C21AY1	25.9	115.0	2.7	21.4	0.06	QD-NG-0300-0002-CM	
						1.020	4.528	.105	.843			
	25	60.0	53.5	2	QD-NN1G45C25AY1	31.9	145.0	2.7	25.0	0.08	QD-NG-0300-0002-CM	
						1.256	5.709	.105	.984			
25	60.0	68.8	2	QD-NN1G60C25AY1	31.9	145.0	2.7	25.0	0.08	QD-NG-0300-0002-CM		
					1.256	5.709	.105	.984				
K	25	60.0	69.0	2	QD-NN1K60C25AY1	31.9	144.5	5.7	25.0	0.19	QD-NK-0600-0003-CM	
						1.256	5.689	.223	.984			

CoroCut® QD shank for Y-axis parting

Spring clamp design

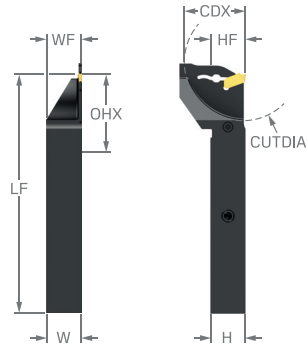

Metric version

SSC	CZC _{MS}	CDX ₁	OHX	CNSC	Ordering code	Dimensions, mm					MIID
						B	H	LF	WF	(KG)	
E	16 x 16	20.0	41.0	2	QD-LFE20C1616D-Y1	16.0	16.0	110.0	15.9	0.19	QD-NE-0200-0002-CM
	20 x 20	20.0	45.0	2	QD-LFE20C2020D-Y1	20.0	20.0	125.0	19.9	0.34	QD-NE-0200-0002-CM
F	20 x 20	20.0	45.0	2	QD-LFF20C2020D-Y1	20.0	20.0	125.0	19.9	0.34	QD-NF-0250-0002-CM
E	16 x 16	20.0	41.0	2	QD-RFE20C1616D-Y1	16.0	16.0	110.0	15.9	0.19	QD-NE-0200-0002-CM
	20 x 20	20.0	45.0	2	QD-RFE20C2020D-Y1	20.0	20.0	125.0	19.9	0.34	QD-NE-0200-0002-CM
F	20 x 20	20.0	45.0	2	QD-RFF20C2020D-Y1	20.0	20.0	125.0	19.9	0.34	QD-NF-0250-0002-CM

Inch version

SSC	CZC _{MS}	CDX ₁	OHX	CNSC	Ordering code	Dimensions, inch					MIID	
						B	H	LF	WF	HF		(LBS)
E	5/8 x 5/8	.787	1.609	2	QD-LFE0800C10D-Y1	.625	.625	4.500	.621	.625	.421	QD-NE-0200-0002-CM
	3/4 x 3/4	.787	1.734	2	QD-LFE0800C12D-Y1	.750	.750	5.000	.746	.750	.690	QD-NE-0200-0002-CM
F	3/4 x 3/4	.787	1.734	2	QD-LFF0800C12D-Y1	.750	.750	5.000	.746	.750	.692	QD-NF-0250-0002-CM
E	5/8 x 5/8	.787	1.609	2	QD-RFE0800C10D-Y1	.625	.625	4.500	.621	.625	.421	QD-NE-0200-0002-CM
	3/4 x 3/4	.787	1.734	2	QD-RFE0800C12D-Y1	.750	.750	5.000	.746	.750	.690	QD-NE-0200-0002-CM
F	3/4 x 3/4	.787	1.734	2	QD-RFF0800C12D-Y1	.750	.750	5.000	.746	.750	.692	QD-NF-0250-0002-CM

CoroCut® XS insert for parting

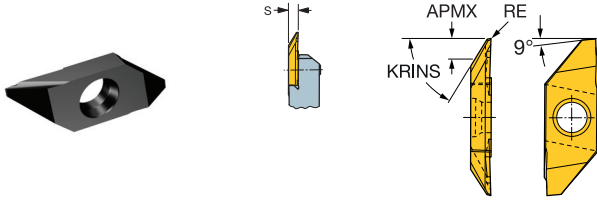

				P	M	S	Dimension s,	
		SSC	RE	Ordering code	1205	1205	AN	
Finishing		3	0.03	MABR/L 3 003	☆	☆	★	6°
			.001	MABR/L 3 005	☆	☆	★	6°
			.002	MABR/L 3 010	☆	☆	★	6°
			.004	MABR/L 3 020	☆	☆	★	6°
			.020	MABR/L 3 020	☆	☆	★	6°
			.008					

CoroCut® XS insert for parting

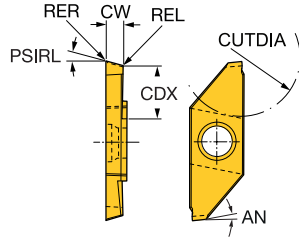
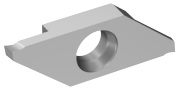

								M N S			Dimensions, mm, inch						
		SSC	CW	REL	RER	CDX	PSIRL	Ordering code	1205	1205	1205	AN	CUTDIA	CWTOLL	CWTOLU	RETOLL	RETOLU
Finishing		3	0.70	0.05	0.05	4.3	15.0°	MACR/L 3 070-L	*	*	*	6°	8.00	-0.020	0.020	-0.030	0.030
			.028	.002	.002	.169							.315	-0.008	.0008	-0.012	.0012
			1.00	0.05	0.05	6.3	15.0°	MACR/L 3 100-L	*	*	*	6°	12.00	-0.020	0.020	-0.030	0.030
			.039	.002	.002	.248							.472	-0.008	.0008	-0.012	.0012
			1.50	0.05	0.05	6.3	15.0°	MACR/L 3 150-L	*	*	*	6°	12.00	-0.020	0.020	-0.030	0.030
			.059	.002	.002	.248							.472	-0.008	.0008	-0.012	.0012
			2.00	0.05	0.05	8.5	15.0°	MACR/L 3 200-L	*	*	*	6°	16.00	-0.020	0.020	-0.030	0.030
	.079	.002	.002	.335							.630	-0.008	.0008	-0.012	.0012		

CoroCut® XS insert for parting

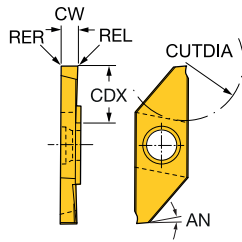

							M	N	S	Dimensions, mm, inch						
		SSC	CW	REL	RER	CDX	Ordering code	1205	1205	1205	AN	CUTDIA	CWTOLL	CWTOLU	RETOLL	RETOLU
Finishing		3	0.70	0.05	0.05	4.3	MACR/L 3 070-N	*	*	*	6°	8.00	-0.020	0.020	-0.030	0.030
			.028	.002	.002	.169						.315	-0.008	.008	-.0012	.0012
			1.00	0.05	0.05	6.3	MACR/L 3 100-N	*	*	*	6°	12.00	-0.020	0.020	-0.030	0.030
			.039	.002	.002	.248						.472	-0.008	.008	-.0012	.0012
			1.50	0.05	0.05	6.3	MACR/L 3 150-N	*	*	*	6°	12.00	-0.020	0.020	-0.030	0.030
			.059	.002	.002	.248						.472	-0.008	.008	-.0012	.0012
			2.00	0.05	0.05	8.5	MACR/L 3 200-N	*	*	*	6°	16.00	-0.020	0.020	-0.030	0.030
	.079	.002	.002	.335						.630	-0.008	.008	-.0012	.0012		

CoroCut® XS insert for parting

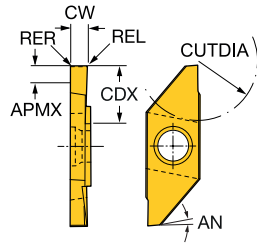

							M	N	S	Dimensions, mm, inch						
		SSC	CW	REL	RER	CDX	Ordering code	1205	1205	1205	AN	CUTDIA	CWTOLL	CWTOLU	RETOLL	RETOLU
Finishing		3	1.00	0.05	0.05	6.3	MACR/L 3 100-T	★	★	★	6°	12.00	-0.020	0.020	-0.030	0.030
			.039	.002	.002	.248						.472	-.0008	.0008	-.0012	.0012
			1.50	0.05	0.05	6.3	MACR/L 3 150-T	★	★	★	6°	12.00	-0.020	0.020	-0.030	0.030
			.059	.002	.002	.248						.472	-.0008	.0008	-.0012	.0012
			2.00	0.05	0.05	8.2	MACR/L 3 200-T	★	★	★	6°	16.00	-0.020	0.020	-0.030	0.030
			.079	.002	.002	.323						.630	-.0008	.0008	-.0012	.0012
			2.50	0.05	0.05	8.2	MACR/L 3 250-T	★	★	★	6°	16.00	-0.020	0.020	-0.030	0.030
			.098	.002	.002	.323						.630	-.0008	.0008	-.0012	.0012

CoroCut® XS insert for parting

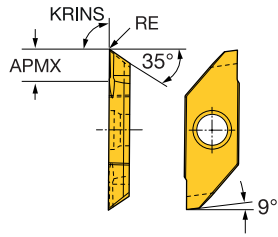
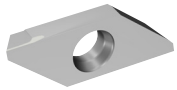

	SSC	RE	Ordering code	P	M	S	Dimension s,
				1205	1205	1205	
	3	0.03	MAFR/L 3 003	☆	☆	★	AN 6°
		.001					
		0.05	MAFR/L 3 005	☆	☆	★	6°
		.002					
		0.10	MAFR/L 3 010	☆	☆	★	6°
		.004					
	0.20	MAFR/L 3 020	☆	☆	★	6°	
	.008						

Milling

CoroMill® MR80

Face milling cutter 89

CoroMill® 365

Inserts 90

CoroMill® MS60

Square shoulder milling cutter 91

Inserts 92



CoroMill® Plura

Solid carbide ball nose end mill 93

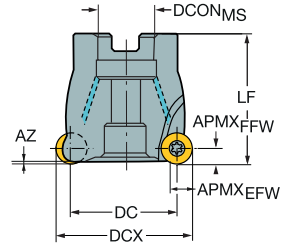
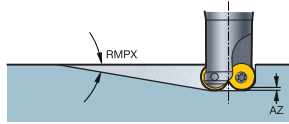
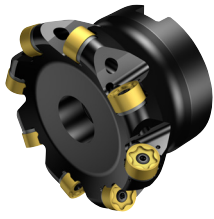
CoroMill® MR80 face milling cutter



Inch version

										Dimensions, inch						
DCX	DC	SSC	CZC _{MS}	APMX _{FFW}	RMPX	CNSC		Ordering code	DCON _{MS}	ISO	LF			RPMX	MIID	
2.000	1.528	1206	3/4	.236	.74°	1	4	MR80-AR051R19-12M	.750	A	1.575	1.4	0.54	9300	MR80-1206..	
	1.528	1206	3/4	.236	.74°	1	6	MR80-AR051R19-12H	.750	A	1.575	1.4	0.58	9300	MR80-1206..	
2.500	2.028	1206	3/4	.236	.59°	1	6	MR80-AR063R19-12M	.750	A	1.969	1.4	1.07	8300	MR80-1206..	
3.000	2.528	1206	1	.236	.43°	1	8	MR80-AR076R25-12M	1.000	A	1.969	1.4	2.05	7400	MR80-1206..	
4.000	3.528	1206	1 1/2	.236	.33°	1	10	MR80-AR102R38-12M	1.500	B	1.969	1.4	2.65	6600	MR80-1206..	

CoroMill® 365 insert for milling

KRINS 65°

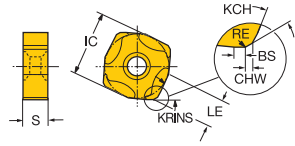
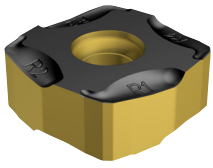

						K				Dimensions, mm, inch				
		SSC	RE	KCH	CHW	Ordering code				IC	LE	S	BS	
Medium	M50	15	0.30	35°	0.7	R/L365-1505ZNM-M50	1020	3220	3330	K20W	15.0	6.4	5.66	1.5
				.012		.028		☆	☆	★	☆	.591	.252	.223



CoroMill® MS60 square shoulder milling cutter

KAPR

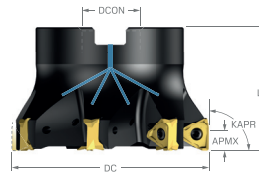
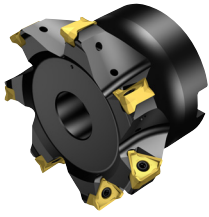

90°



Metric version

										Dimensions, mm					
DC	SSC	CZC _{MS}	APMX _{FFW}	RMPX	AZ	CNSC		Ordering code	DCON _{MS}	ISO	LF			RPMX	MIID
50.0	1605	22	8.00	1.60°	0.7	1	4	MS60-R050Q22-16M	22.0	A	40.0	2.0	0.26	10700	MS60-1605..
50.0	1605	22	8.00	1.60°	0.7	1	5	MS60-R050Q22-16H	22.0	A	40.0	2.0	0.25	10700	MS60-1605..
63.0	1605	22	8.00	1.30°	0.7	1	5	MS60-R063Q22-16M	22.0	A	40.0	2.0	0.45	9600	MS60-1605..
63.0	1605	22	8.00	1.30°	0.7	1	7	MS60-R063Q22-16H	22.0	A	40.0	2.0	0.42	9600	MS60-1605..
80.0	1605	27	8.00	1.00°	0.7	1	7	MS60-R080Q27-16M	27.0	A	50.0	2.0	0.94	8500	MS60-1605..
80.0	1605	27	8.00	1.00°	0.7	1	9	MS60-R080Q27-16H	27.0	A	50.0	2.0	0.94	8500	MS60-1605..
100.0	1605	32	8.00	0.75°	0.5	1	8	MS60-R100Q32-16M	32.0	A	50.0	2.0	1.63	7600	MS60-1605..
100.0	1605	32	8.00	0.75°	0.5	1	11	MS60-R100Q32-16H	32.0	A	50.0	2.0	1.62	7600	MS60-1605..

Inch version

										Dimensions, inch					
DC	SSC	CZC _{MS}	APMX _{FFW}	RMPX	AZ	CNSC		Ordering code	DCON _{MS}	ISO	LF			RPMX	MIID
2.000	1605	3/4	.315	1.80°	.028	1	4	MS60-AR051R19-16M	.750	A	1.500	1.4	0.64	10700	MS60-1605..
2.000	1605	3/4	.315	1.80°	.028	1	5	MS60-AR051R19-16H	.750	A	1.500	1.4	0.64	10700	MS60-1605..
2.500	1605	1	.315	1.40°	.028	1	5	MS60-AR063R25-16M	1.000	A	1.625	1.4	1.06	9600	MS60-1605..
3.000	1605	1	.315	1.10°	.028	1	7	MS60-AR076R25-16M	1.000	A	2.000	1.4	1.81	8500	MS60-1605..
3.000	1605	1	.315	1.10°	.028	1	9	MS60-AR076R25-16H	1.000	A	2.000	1.4	1.76	8500	MS60-1605..
4.000	1605	1 1/2	.315	.80°	.020	1	8	MS60-AR102R38-16M	1.500	A	2.500	1.4	5.47	7600	MS60-1605..
4.000	1605	1 1/2	.315	.80°	.020	1	11	MS60-AR102R38-16H	1.500	A	2.500	1.4	5.45	7600	MS60-1605..

CoroMill® MS60 insert for milling

KRINS 90°

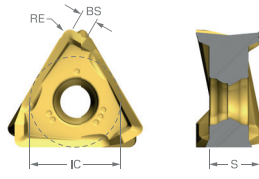
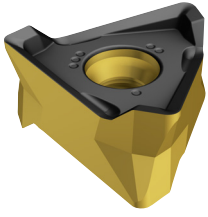

	SSC	RE	Ordering code	P		M		K		S		Dimensions, mm, inch							
				1040	1130	4330	1040	1130	1020	3330	4330	1040	1130	IC	LE	S	BS		
Light L50	1605	0.80	MS60-160508M-L50	☆	★	☆	★	☆	★	☆	★	☆	★	☆	★	9.6	8.0	5.35	1.6
		.031														.378	.315	.211	.063
Medium M40	1605	0.80	MS60-160508M-M40		★	☆		☆	★	☆		☆		★	9.6	8.0	5.35	1.6	
		.031														.378	.315	.211	.063

CoroMill® Plura solid carbide ball nose end mill

Titanium



FHA 30°
TCDCON h6

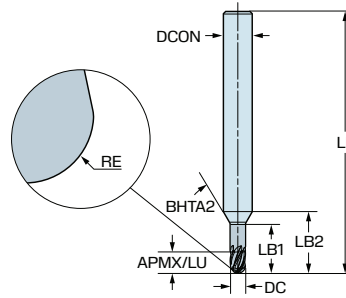

30°
h6

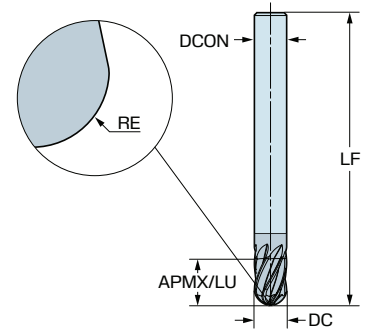

Metric version

DC	CZC _{MS}	APMX	RE ₁	LU	ZEFP	Ordering code	P	M	S	Dimensions, mm		
							TZCH	TZCH	TZCH	DCON _{MS}	LF	LB ₁
3.0	6	4.5	1.50	4.5	5	2B256-0300-TA	☆	☆	★	6.0	57.0	10.5
4.0	6	6.0	2.00	6.0	6	2B256-0400-TA	☆	☆	★	6.0	57.0	13.0
5.0	6	7.5	2.50	7.5	6	2B256-0500-TA	☆	☆	★	6.0	57.0	16.0
6.0	6	9.0	3.00	9.0	6	2B256-0600-TA	☆	☆	★	6.0	57.0	
8.0	8	12.0	4.00	12.0	6	2B256-0800-TA	☆	☆	★	8.0	63.0	
10.0	10	15.0	5.00	15.0	6	2B256-1000-TA	☆	☆	★	10.0	72.0	
12.0	12	18.0	6.00	18.0	6	2B256-1200-TA	☆	☆	★	12.0	83.0	
16.0	16	24.0	8.00	24.0	6	2B256-1600-TA	☆	☆	★	16.0	92.0	
20.0	20	30.0	10.00	30.0	6	2B256-2000-TA	☆	☆	★	20.0	104.0	

Inch version

DC	CZC _{MS}	APMX	RE ₁	LU	ZEFP	Ordering code	P	M	S	Dimensions, inch		
							TZCH	TZCH	TZCH	DCON _{MS}	LF	LB ₁
.125	1/4	.188	.063	.188	5	2B256-0318-TA	☆	☆	★	.250	2.250	.438
.188	1/4	.281	.094	.281	6	2B256-0476-TA	☆	☆	★	.250	2.250	.625
.250	1/4	.375	.125	.375	6	2B256-0635-TA	☆	☆	★	.250	2.250	
.313	5/16	.469	.156	.469	6	2B256-0794-TA	☆	☆	★	.313	2.500	
.375	3/8	.563	.188	.563	6	2B256-0953-TA	☆	☆	★	.375	3.000	
.500	1/2	.750	.250	.750	6	2B256-1270-TA	☆	☆	★	.500	3.500	
.625	5/8	.938	.313	.938	6	2B256-1588-TA	☆	☆	★	.625	3.500	
.750	3/4	1.125	.375	1.125	6	2B256-1905-TA	☆	☆	★	.750	4.000	

CoroMill® Plura solid carbide ball nose end mill

Titanium

FHA
TCDCON 30°
h6

30°
h6

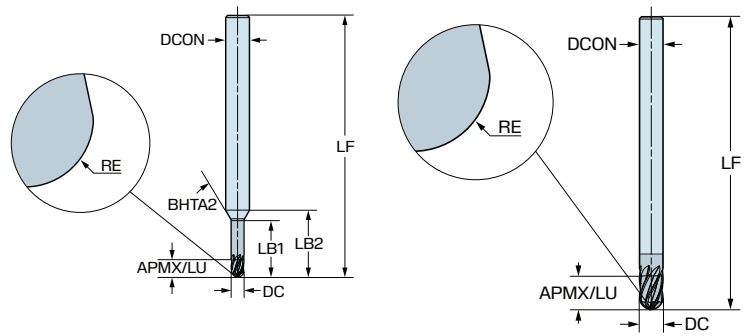

Metric version

DC	CZC _{MS}	APMX	RE ₁	LU	ZEFP	Ordering code	P	M	S	Dimensions, mm		
							T2CH	T2CH	T2CH	DCON _{MS}	LF	LB ₁
3.0	6	4.5	1.50	4.5	5	2B285-0300-TA	☆	☆	★	6.0	70.0	15.0
4.0	6	6.0	2.00	6.0	6	2B286-0400-TA	☆	☆	★	6.0	70.0	20.0
5.0	6	7.5	2.50	7.5	6	2B286-0500-TA	☆	☆	★	6.0	80.0	25.0
6.0	6	9.0	3.00	9.0	6	2B286-0600-TA	☆	☆	★	6.0	80.0	
8.0	8	12.0	4.00	12.0	6	2B286-0800-TA	☆	☆	★	8.0	80.0	
10.0	10	15.0	5.00	15.0	6	2B286-1000-TA	☆	☆	★	10.0	100.0	
12.0	12	18.0	6.00	18.0	6	2B286-1200-TA	☆	☆	★	12.0	105.0	
16.0	16	24.0	8.00	24.0	6	2B286-1600-TA	☆	☆	★	16.0	125.0	
20.0	20	30.0	10.00	30.0	6	2B286-2000-TA	☆	☆	★	20.0	150.0	

Inch version

DC	CZC _{MS}	APMX	RE ₁	LU	ZEFP	Ordering code	P	M	S	Dimensions, inch		
							T2CH	T2CH	T2CH	DCON _{MS}	LF	LB ₁
.125	1/4	.188	.063	.188	5	2B285-0318-TA	☆	☆	★	.250	3.000	.625
.188	1/4	.281	.094	.281	6	2B286-0476-TA	☆	☆	★	.250	3.000	1.000
.250	1/4	.375	.125	.375	6	2B286-0635-TA	☆	☆	★	.250	3.000	
.313	5/16	.469	.156	.469	6	2B286-0794-TA	☆	☆	★	.313	3.500	
.375	3/8	.563	.188	.563	6	2B286-0953-TA	☆	☆	★	.375	4.000	
.500	1/2	.750	.250	.750	6	2B286-1270-TA	☆	☆	★	.500	4.500	
.625	5/8	.938	.313	.938	6	2B286-1588-TA	☆	☆	★	.625	5.000	
.750	3/4	1.125	.375	1.125	6	2B286-1905-TA	☆	☆	★	.750	5.500	

CoroMill® Plura solid carbide ball nose end mill

Titanium

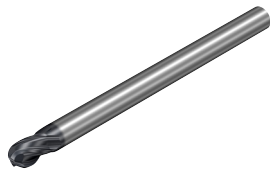

FHA 30°
TCDCON h6

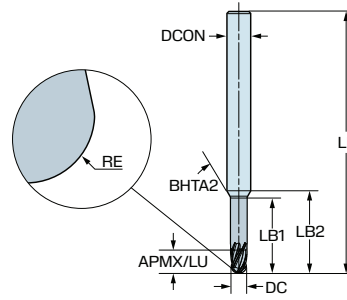

30°
h6

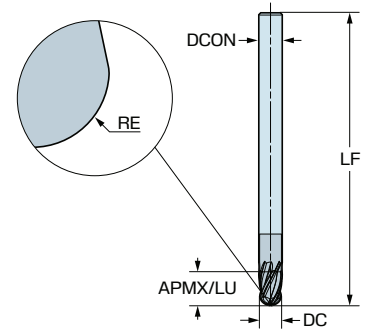

Metric version

DC	CZC _{MS}	APMX	RE ₁	LU	ZEFP	Ordering code	P	M	S	Dimensions, mm		
							TZCH	TZCH	TZCH	DCON _{MS}	LF	LB ₁
3.0	6	4.5	1.50	4.5	4	2B284-0300-TA	☆	☆	★	6.0	70.0	15.0
4.0	6	6.0	2.00	6.0	4	2B284-0400-TA	☆	☆	★	6.0	70.0	20.0
5.0	6	7.5	2.50	7.5	4	2B284-0500-TA	☆	☆	★	6.0	80.0	25.0
6.0	6	9.0	3.00	9.0	4	2B284-0600-TA	☆	☆	★	6.0	80.0	
8.0	8	12.0	4.00	12.0	4	2B284-0800-TA	☆	☆	★	8.0	80.0	
10.0	10	15.0	5.00	15.0	4	2B284-1000-TA	☆	☆	★	10.0	100.0	
12.0	12	18.0	6.00	18.0	4	2B284-1200-TA	☆	☆	★	12.0	105.0	
16.0	16	24.0	8.00	24.0	4	2B284-1600-TA	☆	☆	★	16.0	125.0	
20.0	20	30.0	10.00	30.0	4	2B284-2000-TA	☆	☆	★	20.0	150.0	

Inch version

DC	CZC _{MS}	APMX	RE ₁	LU	ZEFP	Ordering code	P	M	S	Dimensions, inch		
							TZCH	TZCH	TZCH	DCON _{MS}	LF	LB ₁
.125	1/4	.188	.063	.188	4	2B284-0318-TA	☆	☆	★	.250	3.000	.625
.188	1/4	.281	.094	.281	4	2B284-0476-TA	☆	☆	★	.250	3.000	1.000
.250	1/4	.375	.125	.375	4	2B284-0635-TA	☆	☆	★	.250	3.000	
.313	5/16	.469	.156	.469	4	2B284-0794-TA	☆	☆	★	.313	3.500	
.375	3/8	.563	.188	.563	4	2B284-0953-TA	☆	☆	★	.375	4.000	
.500	1/2	.750	.250	.750	4	2B284-1270-TA	☆	☆	★	.500	4.500	
.625	5/8	.938	.313	.938	4	2B284-1588-TA	☆	☆	★	.625	5.000	
.750	3/4	1.125	.375	1.125	4	2B284-1905-TA	☆	☆	★	.750	5.500	

CoroMill® Plura solid carbide ball nose end mill

HRSA

FHA
TCDCON 30°
h6

30°
h6

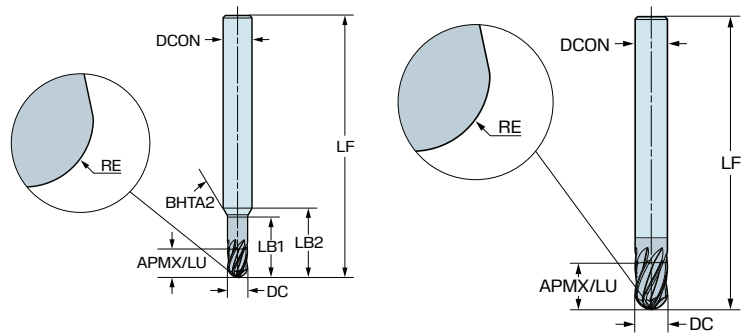

Metric version

DC	CZC _{MS}	APMX	RE ₁	LU	ZEFP	Ordering code	P	K	S	H	Dimensions, mm		
											R2AH	R2AH	R2AH
3.0	6	4.5	1.50	4.5	5	2B255-0300-RA	☆	☆	★	☆	6.0	57.0	10.5
4.0	6	6.0	2.00	6.0	6	2B256-0400-RA	☆	☆	★	☆	6.0	57.0	13.0
5.0	6	7.5	2.50	7.5	6	2B256-0500-RA	☆	☆	★	☆	6.0	57.0	16.0
6.0	6	9.0	3.00	9.0	6	2B256-0600-RA	☆	☆	★	☆	6.0	57.0	
8.0	8	12.0	4.00	12.0	6	2B256-0800-RA	☆	☆	★	☆	8.0	63.0	
10.0	10	15.0	5.00	15.0	6	2B256-1000-RA	☆	☆	★	☆	10.0	72.0	
12.0	12	18.0	6.00	18.0	6	2B256-1200-RA	☆	☆	★	☆	12.0	83.0	
16.0	16	24.0	8.00	24.0	6	2B256-1600-RA	☆	☆	★	☆	16.0	92.0	
20.0	20	30.0	10.00	30.0	6	2B256-2000-RA	☆	☆	★	☆	20.0	104.0	

Inch version

DC	CZC _{MS}	APMX	RE ₁	LU	ZEFP	Ordering code	P	K	S	H	Dimensions, inch		
											R2AH	R2AH	R2AH
.125	1/4	.188	.063	.188	5	2B255-0318-RA	☆	☆	★	☆	.250	2.250	.438
.188	1/4	.281	.094	.281	6	2B256-0476-RA	☆	☆	★	☆	.250	2.250	.625
.250	1/4	.375	.125	.375	6	2B256-0635-RA	☆	☆	★	☆	.250	2.250	
.313	5/16	.469	.156	.469	6	2B256-0794-RA	☆	☆	★	☆	.313	2.500	
.375	3/8	.563	.188	.563	6	2B256-0953-RA	☆	☆	★	☆	.375	3.000	
.500	1/2	.750	.250	.750	6	2B256-1270-RA	☆	☆	★	☆	.500	3.500	
.625	5/8	.938	.313	.938	6	2B256-1588-RA	☆	☆	★	☆	.625	3.500	
.750	3/4	1.125	.375	1.125	6	2B256-1905-RA	☆	☆	★	☆	.750	4.000	

CoroMill® Plura solid carbide ball nose end mill

HRSA

FHA 30°
TCDCON h6

30°
h6

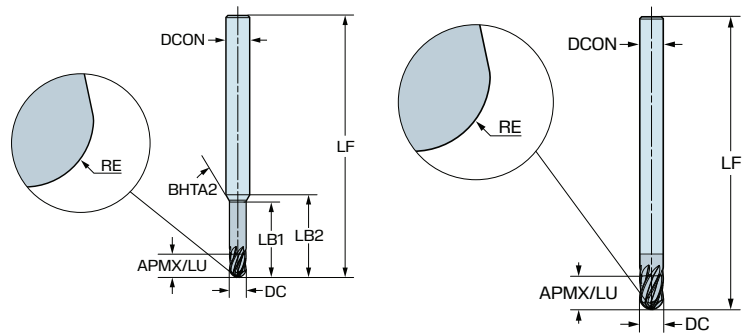

Metric version

DC	CZC _{MS}	APMX	RE ₁	LU	ZEFP	Ordering code	P	K	S	H	Dimensions, mm		
							R2AH	R2AH	R2AH	R2AH	DCON _{MS}	LF	LB ₁
3.0	6	4.5	1.50	4.5	5	2B285-0300-RA	☆	☆	★	☆	6.0	70.0	15.0
4.0	6	6.0	2.00	6.0	6	2B286-0400-RA	☆	☆	★	☆	6.0	70.0	20.0
5.0	6	7.5	2.50	7.5	6	2B286-0500-RA	☆	☆	★	☆	6.0	80.0	25.0
6.0	6	9.0	3.00	9.0	6	2B286-0600-RA	☆	☆	★	☆	6.0	80.0	
8.0	8	12.0	4.00	12.0	6	2B286-0800-RA	☆	☆	★	☆	8.0	80.0	
10.0	10	15.0	5.00	15.0	6	2B286-1000-RA	☆	☆	★	☆	10.0	100.0	
12.0	12	18.0	6.00	18.0	6	2B286-1200-RA	☆	☆	★	☆	12.0	105.0	
16.0	16	24.0	8.00	24.0	6	2B286-1600-RA	☆	☆	★	☆	16.0	125.0	
20.0	20	30.0	10.00	30.0	6	2B286-2000-RA	☆	☆	★	☆	20.0	150.0	

Inch version

DC	CZC _{MS}	APMX	RE ₁	LU	ZEFP	Ordering code	P	K	S	H	Dimensions, inch		
							R2AH	R2AH	R2AH	R2AH	DCON _{MS}	LF	LB ₁
.125	1/4	.188	.063	.188	5	2B285-0318-RA	☆	☆	★	☆	.250	3.000	.625
.188	1/4	.281	.094	.281	6	2B286-0476-RA	☆	☆	★	☆	.250	3.000	1.000
.250	1/4	.375	.125	.375	6	2B286-0635-RA	☆	☆	★	☆	.250	3.000	
.313	5/16	.469	.156	.469	6	2B286-0794-RA	☆	☆	★	☆	.313	3.500	
.375	3/8	.563	.188	.563	6	2B286-0953-RA	☆	☆	★	☆	.375	4.000	
.500	1/2	.750	.250	.750	6	2B286-1270-RA	☆	☆	★	☆	.500	4.500	
.625	5/8	.938	.313	.938	6	2B286-1588-RA	☆	☆	★	☆	.625	5.000	
.750	3/4	1.125	.375	1.125	6	2B286-1905-RA	☆	☆	★	☆	.750	5.500	

Turning tool adaptors

CoroTurn® SL

Damped adaptor	99
Quick change damped adaptor	103

Cylindrical shank to CoroTurn® SL damped adaptor

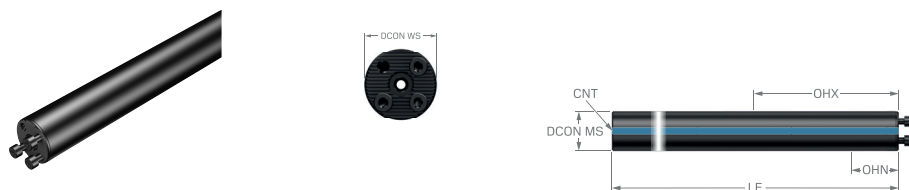

Metric version

							Dimensions, mm						
CZC _{MS}	CZC _{WS}	OHN	OHX	CNSC	CXSC	Ordering code	DCON _{MS}	DCON _{WS}	LF ₁	CNT	BAR	NM	KG
32	32	100.0	192.0	1	1	HT30D-CY32 320-32	32.0	32.0	320.0	G 3/8-19	80	8.8	1.9
		192.0	288.0	1	1	HT30D-CY32 416-32	32.0	32.0	416.0	G 3/8-19	80	8.8	2.6
40	40	128.0	248.0	1	1	HT30D-CY40 408-40	40.0	40.0	408.0	G 1/2-14	80	17.0	4.0
		248.0	368.0	1	1	HT30D-CY40 528-40	40.0	40.0	528.0	G 1/2-14	80	17.0	5.2

Inch version

							Dimensions, inch							
CZC _{MS}	CZC _{WS}	OHN	OHX	CNSC	CXSC	Ordering code	DCON _{MS}	DCON _{WS}	LB ₁	LF ₁	CNT	PSI	FT ³ /LBS	LBS
1 1/4	32	3.740	7.480	1	1	HT30D-CYA20 317-32	1.250	1.260	12.480	12.480	G 3/8-19	1160	6	4.2
		7.480	11.221	1	1	HT30D-CYA20 412-32	1.250	1.260	16.221	16.221	G 3/8-19	1160	6	5.7

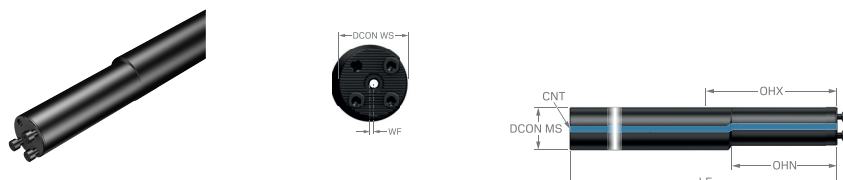

Inch version

							Dimensions, inch								
CZC _{MS}	CZC _{WS}	OHN	OHX	CNSC	CXSC	Ordering code	DCON _{MS}	DCON _{WS}	LB ₁	LF ₁	WF ₁	CNT	PSI	FT ³ /LBS	LBS
1 3/4	40	5.787	11.024	1	1	HT30D-CYA28 457-40	1.750	1.575	4.606	17.992	.088	G 1/2-14	1160	12	9.4
		11.024	16.260	1	1	HT30D-CYA28 590-40	1.750	1.575	9.331	23.228	.088	G 1/2-14	1160	12	13.2

Cylindrical shank to CoroTurn® SL damped adaptor

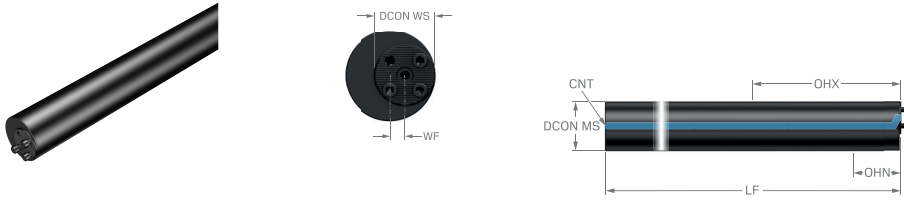

Metric version

					Dimensions, mm								
CZC _{MS}	OHX	OHN	CNSC	Ordering code	DCON _{MS}	DCON _{WS}	BD ₁	LF ₁	WF ₁	CNT	BAR	NM	KG
50	318.0	168.0	1	HT30D-CY50 518-40	50.0	40.0	50.0	518.0	5.0	G 1/2-14	80	17.0	7.80
50	468.0	318.0	1	HT30D-CY50 668-40	50.0	40.0	50.0	668.0	5.0	G 1/2-14	80	17.0	9.86
60	388.0	208.0	1	HT30D-CY60 628-40	60.0	40.0	60.0	628.0	10.0	G 3/4-14	80	17.0	12.87
60	568.0	388.0	1	HT30D-CY60 808-40	60.0	40.0	60.0	808.0	10.0	G 3/4-14	80	17.0	16.10

Inch version

					Dimensions, inch								
CZC _{MS}	OHX	OHN	CNSC	Ordering code	DCON _{MS}	DCON _{WS}	BD ₁	LF ₁	WF ₁	CNT	PSI	FT/LBS	LBS
1 1/2	9.252	4.764	1	HT30D-CYA24 387-32	1.500	1.260	1.500	15.236	.120	G 1/2-14	1160	6.5	6.614
1 1/2	13.74	9.252	1	HT30D-CYA24 501-32	1.500	1.260	1.500	19.724	.120	G 1/2-14	1160	6.5	9.700
2	12.75	6.772	1	HT30D-CYA32 527-40	2.000	1.575	2.000	20.748	.197	G 1/2-14	1160	12.5	17.637
2	18.74	12.75	1	HT30D-CYA32 679-40	2.000	1.575	2.000	26.732	.197	G 1/2-14	1160	12.5	22.840
2 1/2	16.26	8.780	1	HT30D-CYA40 667-40	2.500	1.575	2.500	26.260	.463	G 3/4-14	1160	12.5	33.951
2 1/2	23.74	16.26	1	HT30D-CYA40 857-40	2.500	1.575	2.500	33.740	.463	G 3/4-14	1160	12.5	52.470

ENG

Cylindrical shank to CoroTurn® SL damped adaptor

For threading and grooving operations

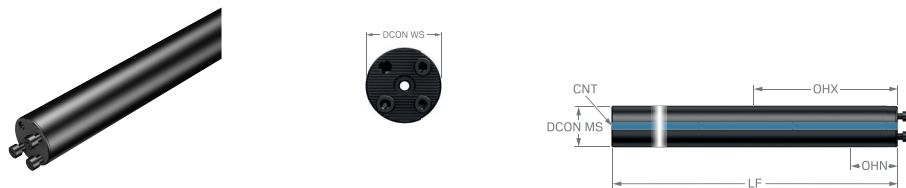

Metric version

					Dimensions, mm							
CZC _{MS}	CZC _{WS}	OHX	CNSC	CXSC	Ordering code	DCON _{MS}	DCON _{WS}	LF ₁	CNT	BAR	NM	KG
40	40	128.0	1	1	HT40D-CY40 288-40	40.0	40.0	288.0	G 1/2-14	80	17.0	2.7

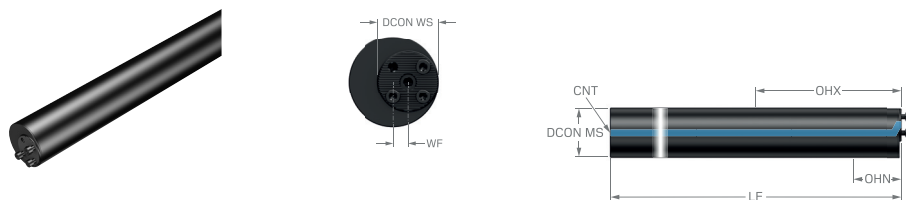

Metric version

					Dimensions, mm							
CZC _{MS}	OHX	CNSC	Ordering code	DCON _{MS}	DCON _{WS}	BD ₁	LF ₁	WF ₁	CNT	BAR	NM	KG
50	168.0	1	HT40D-CY50 368-40	50.0	40.0	50.0	368.0	5.0	G 1/2-14	80	17.0	5.60
60	208.0	1	HT40D-CY60 448-40	60.0	40.0	60.0	448.0	10.0	G 3/4-14	80	17.0	9.50

Cylindrical shank to CoroTurn® SL damped adaptor

For threading and grooving operations

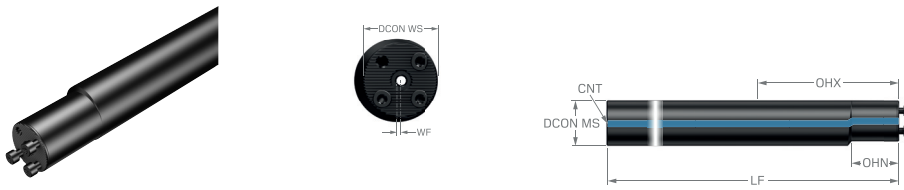

Inch version

					Dimensions, inch									
CZC _{MS}	CZC _{WS}	OHX	CNSC	CXSC	Ordering code	DCON _{MS}	DCON _{WS}	LB ₁	LF ₁	WF ₁	CNT	PSI	FT/LBS	LBS
1 3/4	40	5.787	1	1	HT40D-CYA28 324-40	1.750	1.575	2.047	12.756	.088	G 1/2-14	1160	12	9.3

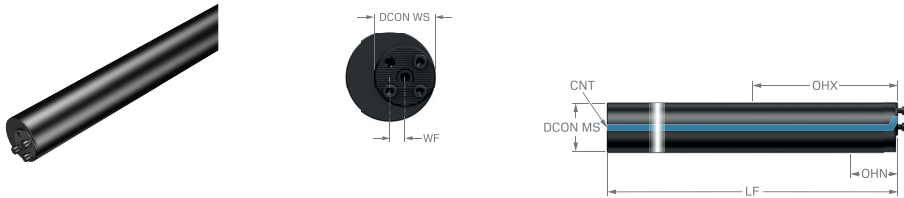

Inch version

					Dimensions, inch									
CZC _{MS}	OHX	CNSC	Ordering code	DCON _{MS}	DCON _{WS}	BD ₁	LF ₁	WF ₁	CNT	PSI	FT/LBS	LBS		
1 1/2	4.764	1	HT40D-CYA24 273-32	1.500	1.260	1.500	10.748	.120	G 1/2-14	1160	6.5	5.952		
2	6.772	1	HT40D-CYA32 375-40	2.000	1.575	2.000	14.764	.197	G 1/2-14	1160	12.5	13.007		
2 1/2	8.740	1	HT40D-CYA40 476-40	2.500	1.575	2.500	18.740	.463	G 3/4-14	1160	12.5	29.101		

Cylindrical shank to CoroTurn® SL quick change damped adaptor



Metric version

							Dimensions, mm						
CZC _{MS}	CZC _{WS}	OHN	OHX	CNSC	CXSC	Ordering code	DCON _{MS}	DCON _{WS}	LF ₁	CNT	(BAR)	(NM)	(KG)
80	80	515.0	755.0	1	1	HT30D-CY80 1075-80	80.0	80.0	1075.0	G 3/4-14	80	50.0	43.4
		275.0	515.0	1	1	HT30D-CY80 835-80	80.0	80.0	835.0	G 3/4-14	80	50.0	31.3

Inch version

							Dimensions, inch							
CZC _{MS}	CZC _{WS}	OHN	OHX	CNSC	CXSC	Ordering code	DCON _{MS}	DCON _{WS}	LB ₁	LF ₁	CNT	(PSI)	(FT/LBS)	(LBS)
3	80	19.252	28.268	1	1	HT30D-CYA48 1022-80	3.000	3.150	40.236	40.236	G 3/4-14	1160	36	83.6
		10.236	19.252	1	1	HT30D-CYA48 793-80	3.000	3.150	31.221	31.221	G 3/4-14	1160	36	59.5

Cylindrical shank to CoroTurn® SL quick change damped adaptor



Metric version

		Dimensions, mm											
CZC _{MS}	OHX	OHN	CNSC	Ordering code	DCON _{MS}	DCON _{WS}	BD ₁	LF ₁	WF ₁	CNT	BAR	NM	KG
100	655.0	355.0	1	HT30D-CY100 1055R/L80	100.0	80.0	100.0	1055.0	10.0	G 3/4-14	80	50.0	63.00
100	955.0	655.0	1	HT30D-CY100 1355R/L80	100.0	80.0	100.0	1355.0	10.0	G 3/4-14	80	50.0	88.00

Inch version

		Dimensions, inch											
CZC _{MS}	OHX	OHN	CNSC	Ordering code	DCON _{MS}	DCON _{WS}	BD ₁	LF ₁	WF ₁	CNT	PSI	FT/LBS	LBS
4	26.26	14.25	1	HT30D-CYA64 1073R/L80	4.000	3.150	4.000	42.244	.394	G 3/4-14	1160	36.9	146.16
4	38.22	26.22	1	HT30D-CYA64 1377R/L80	4.000	3.150	4.000	54.213	.394	G 3/4-14	1160	36.9	200.62

Accessories

Tool status checker for CoroTurn® SL

106

Tool status checker for CoroTurn® SL



Ordering code**SL-TSC-01**

ISO 13399 is an international standard that strives to simplify the exchange of data for cutting tools. You will notice a slight difference through the new parameters and descriptions of each tool.

For the first time ever, there is a standardized way of describing product data regarding cutting tools. When all tools in the industry share the same parameters and definitions, communicating tool information becomes very straightforward.

What does this mean to you?

Basically, it means that your systems can talk to ours, as they all speak the same language. Download product data from our web site and use it directly in your CAD/CAM software to assemble tools that you use in production. No need to look for information in catalogues and interpret data from one system to another. Imagine how much time this will save you!



Short name	Preferred Name
ADJLN	Minimum adjustment limit
ADJLX	Maximum adjustment limit
ADJRG	Adjustment range
ALP	Clearance angle axial
AN	Clearance angle major
ANN	Clearance angle minor
APMX	Depth of cut maximum
APMX_EFW	Depth of cut maximum - end feed
APMX_FFW	Depth of cut maximum - side feed
AZ	Maximum plunge depth
B	Shank width
BAWS	Body angle workpiece side
BAMS	Body angle machine side
BBD	Balanced by design
BBR	Balanced by rotational test
BCH	Corner chamfer length
BD	Body diameter
BHTA	Body half taper angle
BN	Face land width
BS	Wiper edge length
BSG	Basic standard group
BSR	Wiper edge radius
CBMD	Chip breaker manufacturer
CDX	Cutting depth maximum
CEMR	Cutting edge major radius
CF	Spot chamfer
CHBA	Chamfer body angle
CHBL	Chamfer body length
CHW	Corner chamfer width
CICT	Cutting item count
CICT _{BALL}	Cutting item count - Ball nose insert
CICT _E	Cutting item count - end position
CICT _P	Cutting item count - peripheral position
CICT _S	Cutting item count - side position
CICT _{SP}	Cutting item count - Shank protection insert
CICT _T	Cutting item count - total
CND	Coolant entry diameter
CNSC	Coolant entry style code
CNT	Coolant entry thread size
COATING	Coating
CP	Max coolant pressure
CRKS	Connection retention knob thread size
CRNT	Coolant radial entry thread size
CTPT	Operation type
CUTDIA	Work piece parting diameter maximum
CW	Cutting width
CWN	Minimum cutting width
CWTOLL	Cutting width lower tolerance
CWTOLU	Cutting width upper tolerance
CWX	Cutting width maximum
CXSC	Coolant exit style code
CZC	Connection size code
CZC _{MS}	Connection size code machine side
CZC _{WS}	Connection size code workpiece side
D1	Fixing hole diameter
DAH	Diameter access hole
DAXIN	Axial groove inside diameter minimum
DAXN	Minimum axial groove outside diameter

DAXX	Axial groove outside diameter maximum
DBC	Diameter bolt circle
DC	Cutting diameter
DCB	Connection bore diameter
DCBN	Connection bore diameter minimum
DCBX	Connection bore diameter maximum
DCF	Cutting diameter face contact
DCIN	Cutting diameter internal
DCN	Cutting diameter minimum
DCON	Connection diameter
DCON _{MS}	Connection diameter machine side
DCON _{WS}	Connection diameter workpiece side
DCONN _{WS}	Connection diameter minimum workpiece side
DCONX _{WS}	Connection diameter maximum workpiece side
DCPS	Data chip provision size
DCSF _{MS}	Contact surface diameter machine side
DCSF _{WS}	Contact surface diameter workpiece side
DCX	Cutting diameter maximum
DHUB	Hub diameter
DIX	Tool changer interference diameter maximum
DMIN	Minimum bore diameter
DMM	Shank diameter
DN	Neck diameter
DRVCT	Drive count
DSGN	Design
EPSR	Insert included angle
FHA	Flute helix angle
FLGT	Flange thickness
FTDZ	For thread diameter size
GB	Face land angle
H	Shank height
HA	Thread height theoretical
HB	Thread height difference
HBH	Head bottom offset height
HC	Thread height actual
HF	Functional height
HRY	Lowest point from reference plain
HSUP	Support height
HTB	Body height
HTH	Height
IC	Inscribed circle diameter
INSL	Insert length
INSUC	Insert usage code
IZC	Insert size code
KAPR	Tool cutting edge angle
KAPR_EFW	Tool cutting edge angle - end feed
KCH	Corner chamfer
KRINS	Major cutting edge angle
KWW	Keyway width
L	Cutting edge length
LAMS	Inclination angle
LB	Body length
LCF	Length chip flute
LCOX	Cut off length maximum
LE	Cutting edge effective length
LF	Functional length
LFN	Minimum functional length
LH	Head length
LPR	Protruding length
LS	Shank length
LSC	Clamping length
LSCN	Clamping length minimum
LSCS	Distance to clamping start
LSCX	Clamping length maximum
LSD	Dead shank length
LU	Usable length (max. recommended)
LU_BFW	Usable length - back facing
LUX	Usable length maximum
MHD	Mounting hole distance
MIID	Master insert identification
MIID _E	Master insert identification - end position
MIID _S	Master insert identification - side position
MIID _C	Master insert identification - central position
MIID _P	Master insert identification - peripheral position
MIID _I	Master insert identification - intermediate position
MMCC	Code for preset torque
MMCX	Max. cutting torque
NOF	Flute count
NT	Tooth count
OAH	Overall height
OAL	Overall length
OAW	Overall width
OH	Overhang recommended
OHN	Overhang minimum

OHX	Overhang maximum
ORDCODE	Ordercode
PCL	Peripheral cylindrical length
PDX	Profile distance ex
PDY	Profile distance ey
PHD	Premachined hole diameter
PHDX	Maximum premachined hole diameter
PL	Point length
PNA	Profile included angle
PRFRAD	Profile radius
PRSPC	Profile specification
PSIR	Tool lead angle
PSIRL	Cutting edge angle major left hand
PSIRR	Cutting edge angle major right hand
PSW	Premachined slot width
RADH	Radial body height
RADW	Radial body width
RAR	Right hand relief angle
RE	Corner radius
REEQ	Corner radius equivalent
REL	Corner radius left
RER	Corner radius right
RETOLL	Corner radius lower tolerance
RETOLU	Corner radius upper tolerance
RGL	Regrind length
RMPX	Maximum ramping angle
RPMX	Rotational speed maximum
S	Insert thickness
SDL	Step diameter length
SIG	Point angle
SPTL	Splitline
SSC	Insert seat size code
SSC _E	Insert seat size code - end position
SSC _P	Insert seat size code - peripheral position
SSC _S	Insert seat size code - side position
STA	Step included angle
STDNO	Standard number
SUBSTRATE	Substrate
TCDC	Tolerance class cutting diameter
TCDCON	Connection diameter tolerance
TCDMM	Shank diameter tolerance
TCHA	Achievable hole tolerance
TCHAL	Achievable hole tolerance lower
TCHAU	Achievable hole tolerance upper
TCT	Tolerance class tool
TCTR	Thread tolerance class
TD	Thread diameter
TDZ	Thread diameter size
TFLA	Tap floating length ahead
TFLB	Tap floating length behind
TG	Taper gradient
THBTP	Thread back taper property
THCA	Thread helix correction angle
THCHT	Threading chamfer type
THFT	Form type
THFTS	Thread form standard series
THL	Thread length
THUB	Hub thickness
TP	Thread pitch
TPI	Threads per inch
TPIN	Threads per inch minimum
TPIX	Threads per inch maximum
TPN	Thread pitch minimum
TPT	Thread profile type
TPX	Maximum thread pitch
TRMAX	Tap range max
TQ	Torque
TSYC	Tool style code
TPP	Thread type
ULDR	Usable length diameter ratio
VCX	Maximum cutting speed
W1	Insert width
WB	Body width
WF	Functional width
WFCIRP	Width to cutting item reference point
WSC	Clamping width
WT	Weight of item
ZADJ	Insert adjustable count
ZEFF	Face effective cutting edge count
ZEFP	Peripheral effective cutting edge count (ZEFP)
ZWX	Maximum number of Wiper inserts



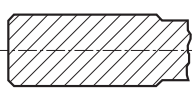
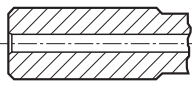
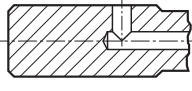
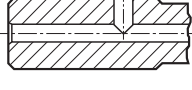
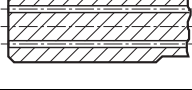
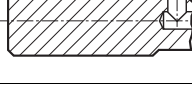
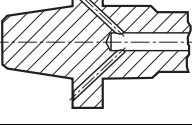
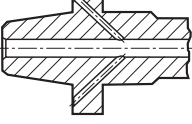

CNSC

Coolant entry style code

Code	Description	Image
0	Without coolant	
1	Axial concentric entry	
2	Radial entry	
3	Axial concentric and radial entry	
4	Axial concentric entry on circle	
5	Radial entry before adaptor	
6	Decentral over flange	
7	Decentral over flange and axial	
8	Decentral over slots on the shank	

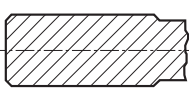
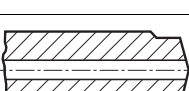
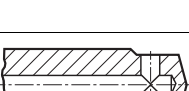
CXSC

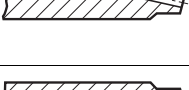
Coolant exit style code

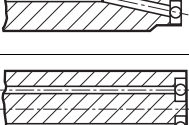
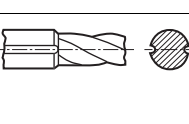
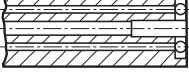
Code	Description	Image
0	No coolant exit	
1	Axial concentric exit	
2	Radial exit	
3	Axial inclined exit	
4	Axial concentric on circle	
5	Axial inclined exit with nozzle, adjustable	
6	Decentral exit with nozzle, adjustable	
7	Decentral over slots on the shank	
8	Axial or decentral with nozzle, adjustable	

Safety information in connection with grinding of cemented carbide

Material composition

Most metal products contain tungsten carbide and cobalt. Other substances that may be present in hard metal are titanium carbide, tantalum carbide, niobium carbide, chromium carbide, molybdenum carbide or vanadium carbide. Some grades contain titanium carbonitride and/or nickel.

Routes of exposure

Grinding or heating of hard metal blanks or hard metal products will produce products that give off dangerous dust and fumes. Avoiding ingestion and contact with skin or eyes is very important.

Acute toxicity

Intake of the aforementioned substances is toxic. Inhalation may cause irritation and inflammation of the airways. Significantly higher acute inhalation toxicity has been reported during simultaneous inhalation of cobalt and tungsten carbide compared to inhalation of cobalt alone.

Skin contact can cause irritation and rash. Sensitive individuals may even experience an allergic reaction.

Chronic toxicity

Repeated inhalation of aerosols containing cobalt may cause obstruction of the airways. Prolonged exposure to increased concentrations may cause lung fibrosis or lung cancer. Epidemiological studies indicate that workers previously exposed to high concentrations of tungsten carbide/cobalt carried an increased risk of developing lung cancer.

Cobalt and nickel are potent skin sensitizers. Repeated or prolonged contact can cause irritation and sensitization.

Risk phrases

Toxic: danger of serious damage to health by prolonged exposure through inhalation

Toxic when inhaled

Limited evidence of a carcinogenic effect.

May cause sensitization by inhalation and skin contact

Preventive measures

Avoid formation and inhalation of dust. Use adequate local exhaust ventilation to keep personal exposure well below nationally authorised limits.

If ventilation is not available or adequate, use respirators appropriately approved for the purpose.

Use safety goggles or glasses with side shields when necessary.

Avoid repeated skin contact. Wear suitable gloves. Wash skin thoroughly after handling.

Use suitable protective clothing. Launder clothing if needed.

Do not eat, drink or smoke in the working area. Wash skin thoroughly before eating, drinking or smoking.



For the sake of the environment

Get into the Sandvik Coromant Recycling Concept (CRC) now!

The Sandvik Coromant Recycling Concept (CRC) is a comprehensive service for used carbide inserts and solid carbide tools offered by Sandvik Coromant to all its customers.

In the light of increasing consumption of non-renewable raw materials, the economic management of dwindling resources is a duty owed by all manufacturers.

Sandvik Coromant is playing its part by offering to collect used carbide inserts and solid carbide tools and recycle them in the most environmentally friendly way.

All used carbide inserts are collected in the collection box at the workplace.

When the collection box is sufficiently full, its contents are transferred to the transport box.

The full transport box is then sent to the nearest Sandvik Coromant office or to your Sandvik Coromant dealer who can also give you more information.

The benefits of the CRC speak for themselves

- A worldwide ISO and OHAS certified recycling system.
- Open to all Sandvik Coromant customers.
- Simple procedure with collection and transport boxes.
- Less waste, easing the burden on the environment.
- Better utilisation of resources.
- Other manufacturers' carbide inserts are also accepted.



Order collection boxes for each lathe, milling machine, drill or for your machining centre. We recommend one collection box for inserts and one separate box for solid carbide tools for each cutting workplace.

For detailed instructions on how to sell your used cemented carbide, please visit www.sandvik.coromant.com and select your market.

Collection box:	Order numbers
Transport box for solid carbide tools (plywood):	91617
Transport box inserts (plywood):	92994
	92995

